

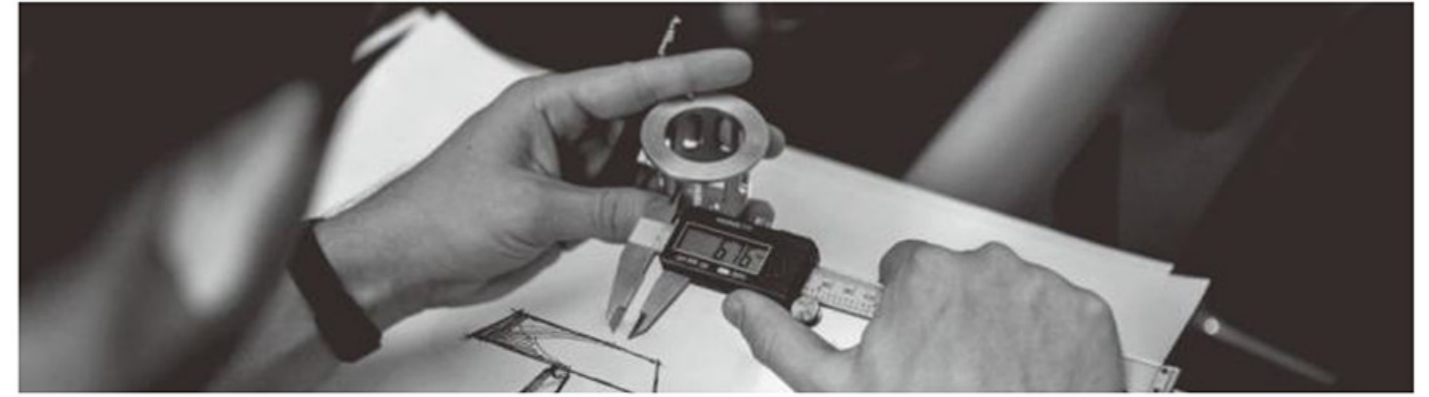

HYGGE
MODERN LIGHTING

Commercial **Collection**
2025



EXTREME LIFE
AESTHETICS FROM POINT
LINE AND SURFACE
FROM DESIGN INNOVATION
TO LIGHT DESIGN INSTITUTE

HYGGE
MODERN LIGHTING

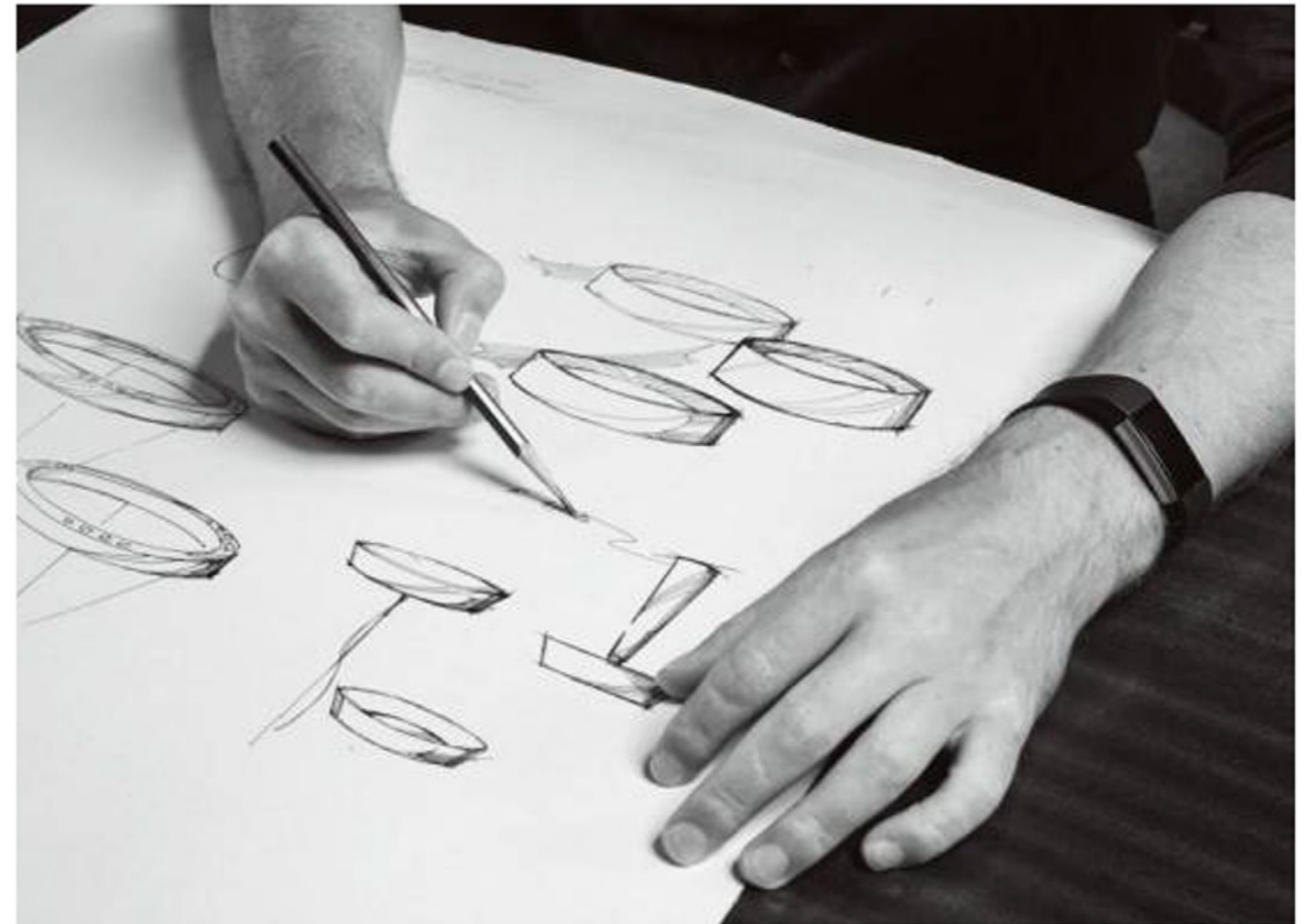

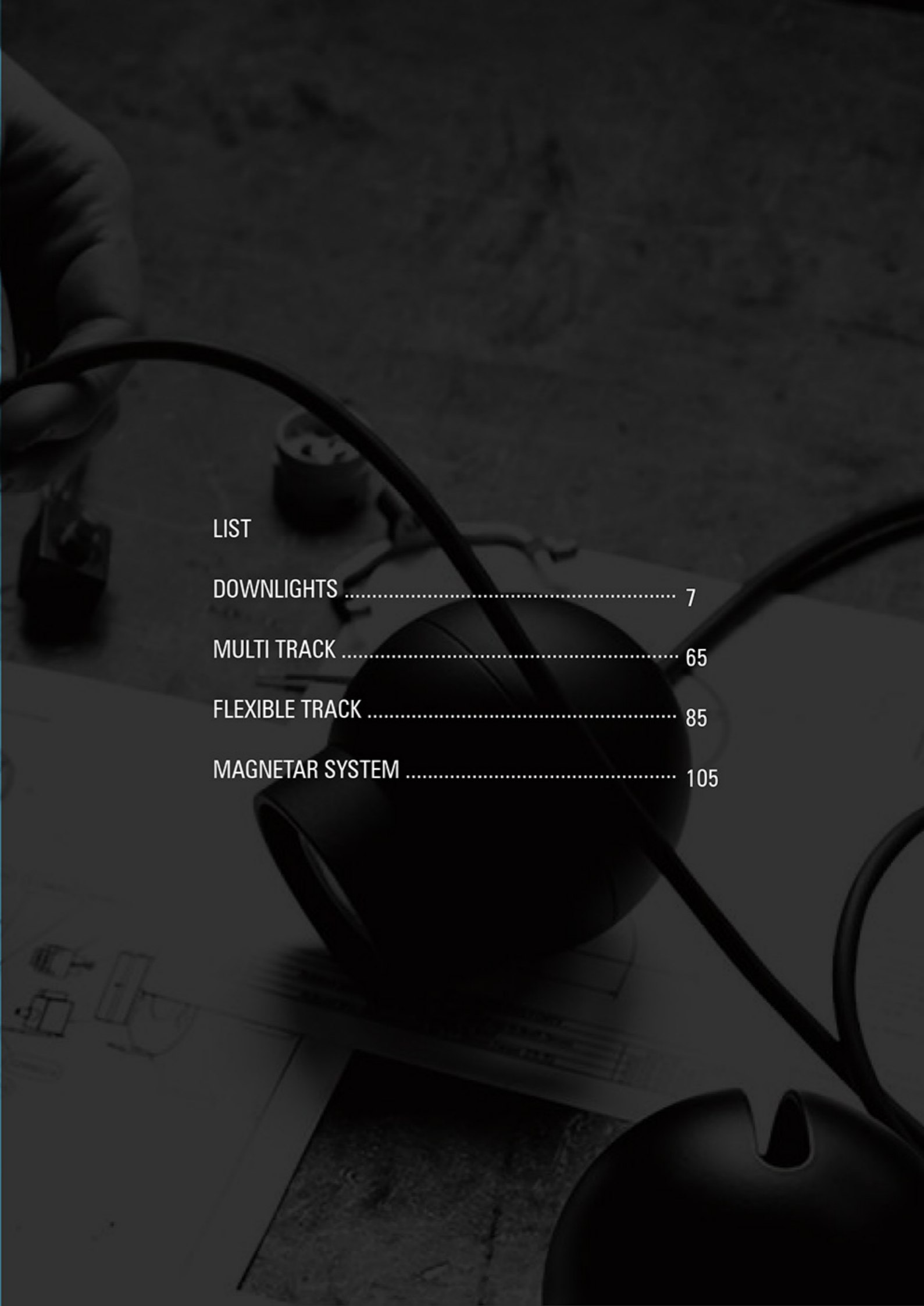

LIST

DOWNLIGHTS	7
MULTI TRACK	65
FLEXIBLE TRACK	85
MAGNETAR SYSTEM	105

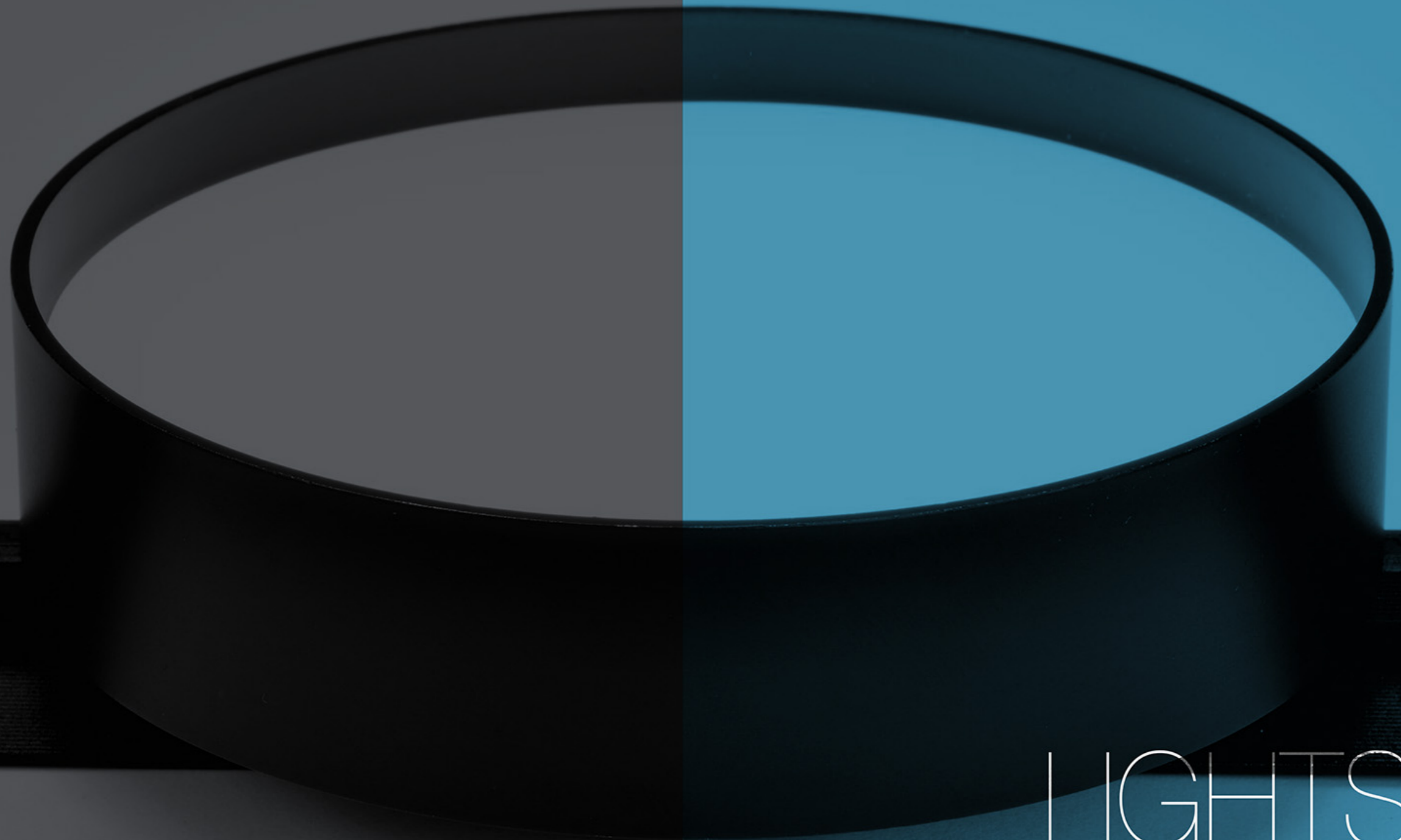

LIGHTS

COMMERCIAL

DOWNLIGHTS

Downlights are modern, stylish, and efficient lighting fixtures that are installed into the ceiling. They provide focused and ambient lighting, making them ideal for homes, offices, and commercial spaces. With LED options, downlights are energy-saving and long-lasting creating a sleek and clutter-free look in any interior.

Benefits of Downlights:

- Space-saving & modern design
- Energy-efficient with LED technology
- Provides even and warm illumination
- Ideal for task, accent, and general lighting

PRODUCT INDEX



PINE NEEDLE DA25
001-004



UNBOUNDED DA35
005-010



STEALTHSHINE DA34
011-014



MORNING DEW DA91
015-018



RAIN CURTAIN DA92
019-022

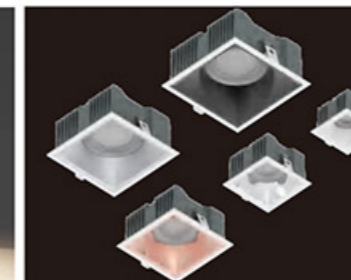

FANG TONG DA49
023-032



MONOLOGUE DA28
033-036



COREAWN DB84
037-042



REVERBERATE DA36
043-056



MICROFLAME DA39
057-058

SMALL HOLE LIGHT MORE ANTI-GLARE

DA25 series simple design style, with all aluminum die-cast lamp body, Highlight product quality and texture from the details;

Small aperture, narrow light Angle, more accurate light control, more accurate and delicate lighting,

Beam Angle $> 60^\circ$, UGR < 6 , very anti-glare, To maximize the quiet and elegant space lighting atmosphere.

After the lamp shade face ring is installed, it is integrated with the ceiling.

TO meet the different design styles, Suit to professional grade, decorative grade high demand lighting."



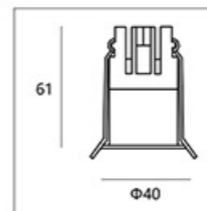

LED brand:
Luminus

CCT:
2700K/3000K/4000K

CRI:
Ra > 90

Size:
Φ40x61

Material:
aluminum

Power:
5W

Voltage & Current:
36V

Cutout:
Φ35

Beam angle:
24°/36°

Mains voltage:
220-240V 50/60Hz

Description:
Downlight

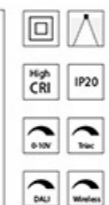
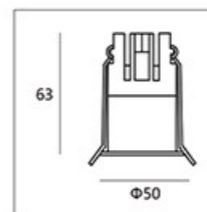

LED brand:
Luminus

CCT:
2700K/3000K/4000K

CRI:
Ra > 90

Size:
Φ50x63

Material:
aluminum

Power:
7W

Voltage & Current:
36V

Cutout:
Φ45

Beam angle:
24°/36°

Mains voltage:
220-240V 50/60Hz

Description:
Downlight

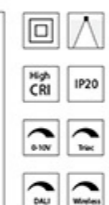
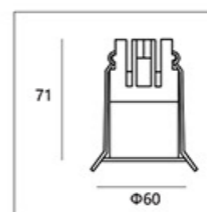

LED brand:
Luminus

CCT:
2700K/3000K/4000K

CRI:
Ra > 90

Size:
Φ60x71

Material:
aluminum

Power:
9W

Voltage & Current:
36V

Cutout:
Φ55

Beam angle:
24°/36°

Mains voltage:
220-240V 50/60Hz

Description:
Downlight

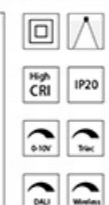
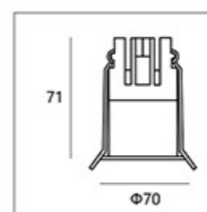

LED brand:
Luminus

CCT:
2700K/3000K/4000K

CRI:
Ra > 90

Size:
Φ70x71

Material:
aluminum

Power:
12W

Voltage & Current:
36V

Cutout:
Φ65

Beam angle:
24°/36°

Mains voltage:
220-240V 50/60Hz

Description:
Downlight

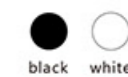

black white



		   	LED brand: OSRAM CCT: 2700K/3000K/4000K CRI: Ra>90 Size: Φ61x67	Material: aluminum Power: 7W Voltage & Current: 36V Cutout: Φ55	Beam angle: 24°/36° Mains voltage: 220-240V 50/60Hz Description: Downlight
---	---	---	--	--	--

		   	LED brand: OSRAM CCT: 2700K/3000K/4000K CRI: Ra>90 Size: Φ80x72	Material: aluminum Power: 12W Voltage & Current: 36V Cutout: Φ75	Beam angle: 24°/36° Mains voltage: 220-240V 50/60Hz Description: Downlight
---	---	---	--	---	--

		   	LED brand: OSRAM CCT: 2700K/3000K/4000K CRI: Ra>90 Size: Φ80x62	Material: aluminum Power: 12W Voltage & Current: 36V Cutout: Φ75	Beam angle: 24°/36° Mains voltage: 220-240V 50/60Hz Description: Downlight
--	--	--	--	---	--



 black white black+white





MASKS ARE AVAILABLE IN
DIFFERENT SETS OF COLORS
AND PLATING COLORS

Downlights are one of the most popular modern lighting options seamlessly integrating into ceilings to create a sleek and minimalist look. Their uniform and well-distributed light makes them an excellent choice for homes, offices, retail stores and hotels.



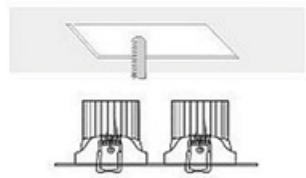
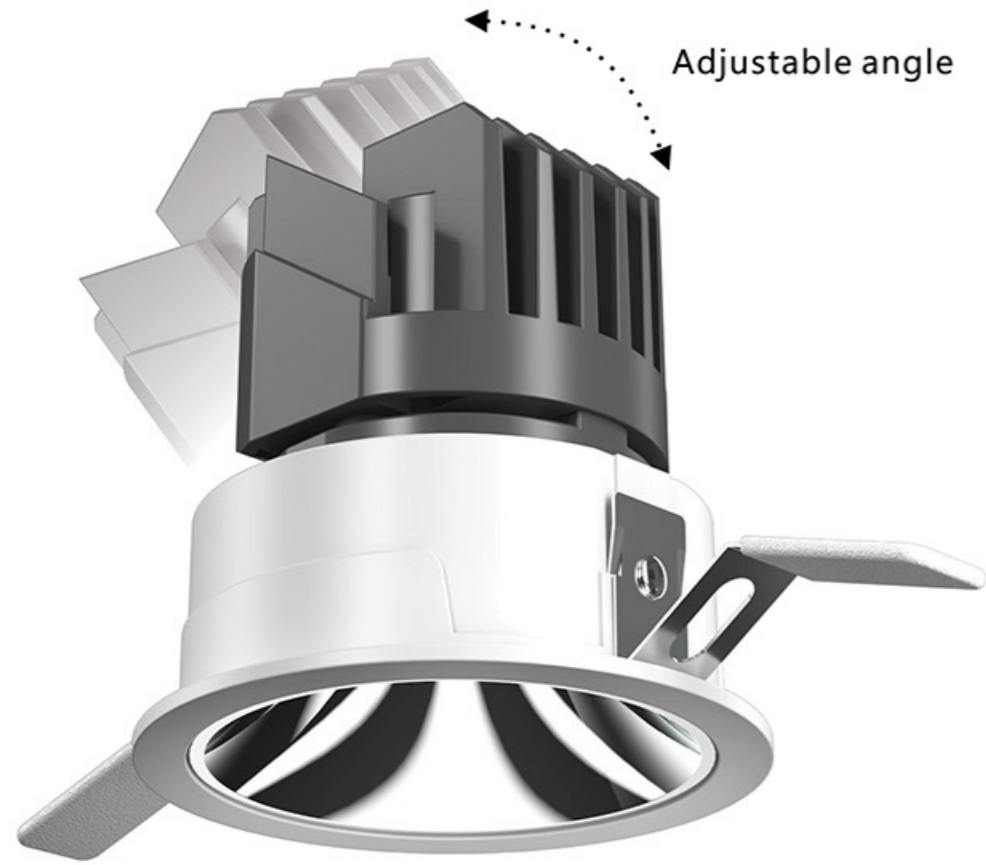

①

Ceiling opening, using tools to open the ceiling to the corresponding size

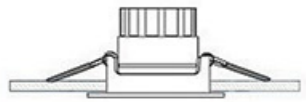

③

Fit the spring clips at both ends vertically into the ceiling openings that match their dimensions

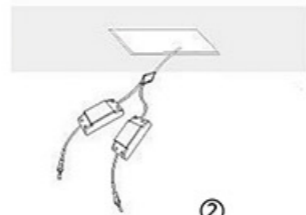

②

Connecting wires to the terminals of lamps and lanterns is recommended to be operated by professional electricians pay attention to safety

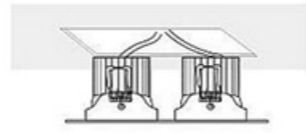

④

Confirm the above operation is correct release the spring buckle to open the power to use that match their dimensions





ART OF COLOR TEMPERATURE

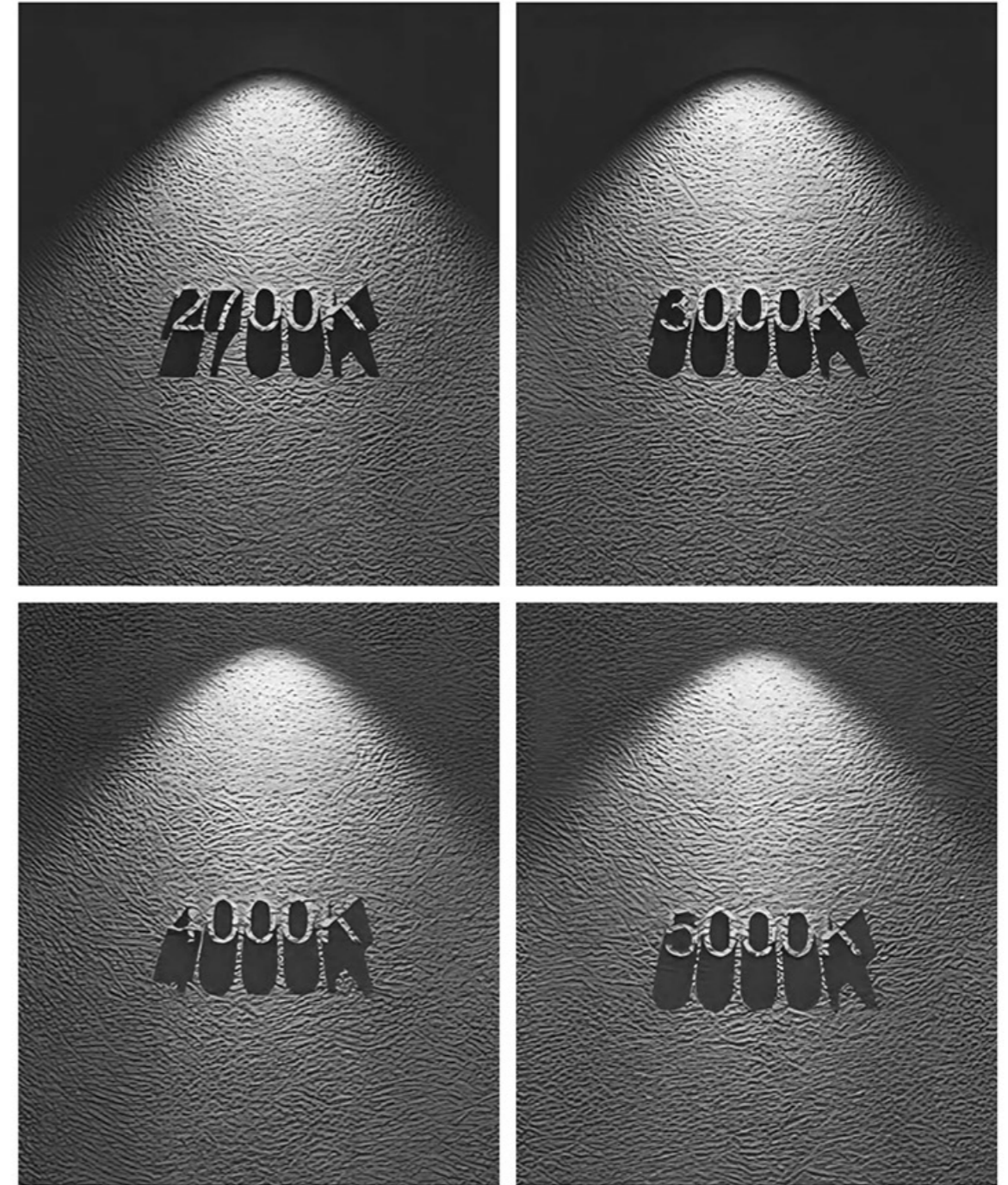

WONDERFUL LIGHT COLOR
SHOW AS IT IS

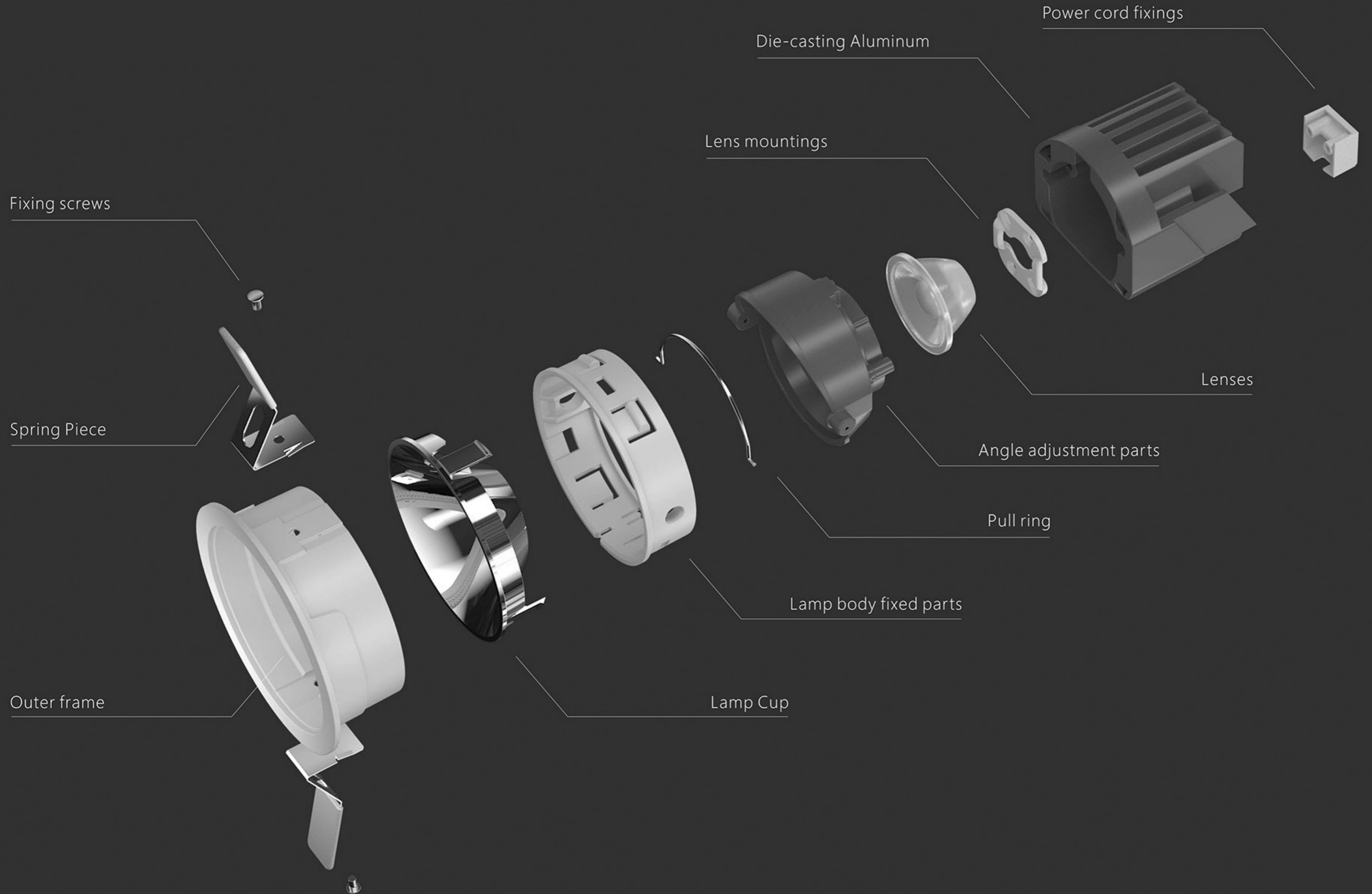



HIDE SHINE

RADIATOR VERY RICH COLOR

DA34 series, small size, delicate process, thickened aviation aluminum heat faster and more durable. The radiator has different color options to meet the needs of different design styles. Excellent lighting quality, ultimate anti-glare design



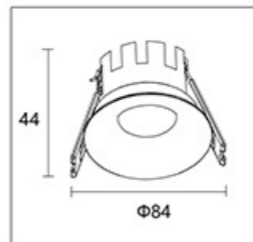

LED brand:
OSRAM

CCT:
2700K/3000K/4000K

CRI:
Ra>90

Size:
Φ84x44

Material:
aluminum

Power:
12W

Voltage & Current:
36V

Cutout:
Φ75

Beam angle:
24°/36°/50°

Mains voltage:
220-240V 50/60Hz

Description:
Downlight

Luminousflux:
950LM

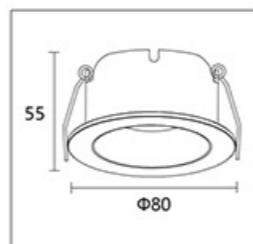

LED brand:
OSRAM

CCT:
2700K/3000K/4000K

CRI:
Ra>90

Size:
Φ80x55

Material:
aluminum

Power:
12W

Voltage & Current:
36V

Cutout:
Φ75

Beam angle:
24°/36°/50°

Mains voltage:
220-240V 50/60Hz

Description:
Downlight

Luminousflux:
950LM

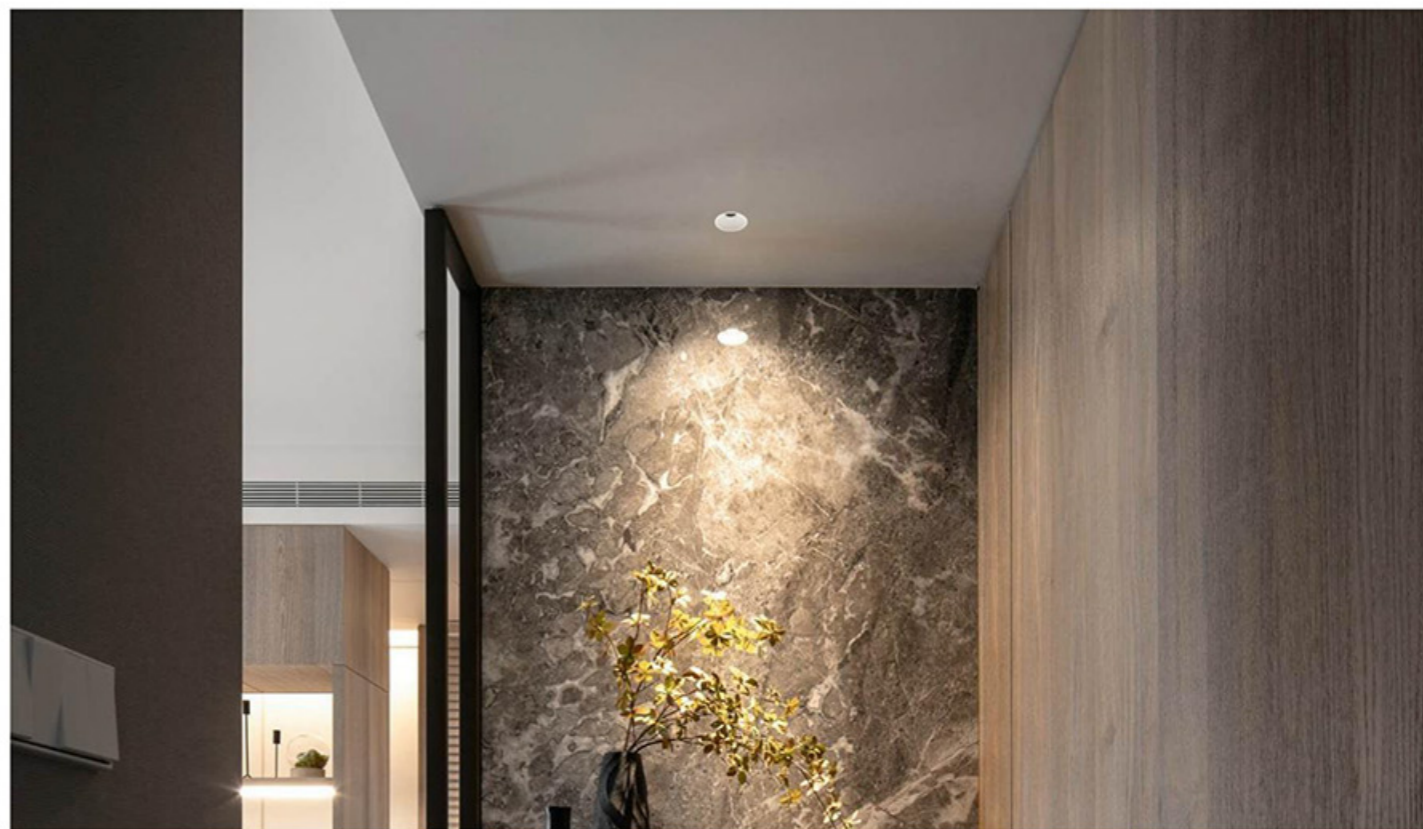

MORNING DEW

WATERPROOF
RECESSED SPOT LIGHT

DA91 series, exquisite craft, simple style atmosphere, IP54 design,
Suitable for bathroom, bathroom, kitchen and other places with high humidity,
Excellent light efficiency, 15°/24°/36°/50°, many angle options,
Suitable for professional grade decoration grade needs.



IP54 WATERPROOF
RECESSED SPOT
LIGHT



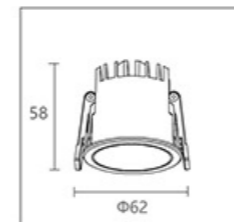

LED brand:
OSRAM

CCT:
2700K/3000K/4000K

CRI:
Ra>90

Size:
Φ62x58

Material:
aluminum

Power:
7W

Voltage & Current:
36V

Cutout:
Φ55

Beam angle:
15°/24°/36°/50°

Mains voltage:
220-240V 50/60Hz

Description:
Downlight

Luminousflux:
400LM

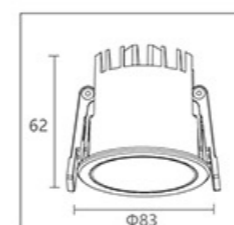

LED brand:
OSRAM

CCT:
2700K/3000K/4000K

CRI:
Ra>90

Size:
Φ83x62

Material:
aluminum

Power:
12W

Voltage & Current:
36V

Cutout:
Φ75

Beam angle:
15°/24°/36°/50°

Mains voltage:
220-240V 50/60Hz

Description:
Downlight

Luminousflux:
800LM

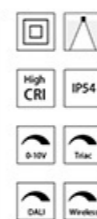
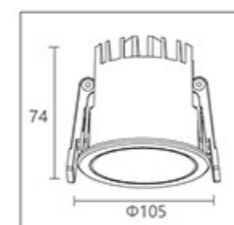

LED brand:
OSRAM

CCT:
2700K/3000K/4000K

CRI:
Ra>90

Size:
Φ105x74

Material:
aluminum

Power:
18W

Voltage & Current:
36V

Cutout:
Φ95

Beam angle:
15°/24°/36°/50°

Mains voltage:
220-240V 50/60Hz

Description:
Downlight

Luminousflux:
1200LM



Matt black Matt white Matt silver Gun black

RAIN CURTAIN

This series exquisite craft, simple style atmosphere, IP54 waterproof design,
Suitable for bathroom, bathroom, kitchen and other places with high humidity,
Excellent light efficiency, 15°/24°/36°/50°, many angle options,
Suitable for professional grade decoration grade needs.



**RAIN
CURTAIN**

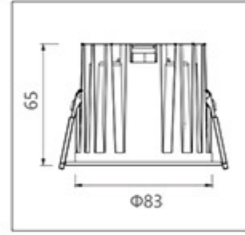

LED brand:
SANAN

CCT:
2700K/3000K/4000K

CRI:
Ra>90

Size:
Φ83x65

Material:
aluminum

Power:
12W

Voltage & Current:
36V

Cutout:
Φ75

Beam angle:
50°

Mains voltage:
220-240V 50/60Hz

Description:
Downlight

Luminousflux:
1200LM

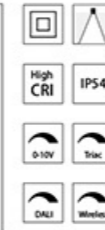
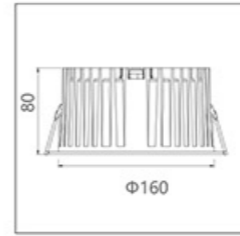

LED brand:
SANAN

CCT:
2700K/3000K/4000K

CRI:
Ra>90

Size:
Φ160x80

Material:
aluminum

Power:
36W

Voltage & Current:
36V

Cutout:
Φ150

Beam angle:
50°

Mains voltage:
220-240V 50/60Hz

Description:
Downlight

Luminousflux:
3900LM

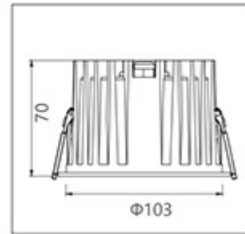

LED brand:
SANAN

CCT:
2700K/3000K/4000K

CRI:
Ra>90

Size:
Φ103x70

Material:
aluminum

Power:
20W

Voltage & Current:
36V

Cutout:
Φ95

Beam angle:
50°

Mains voltage:
220-240V 50/60Hz

Description:
Downlight

Luminousflux:
2000LM

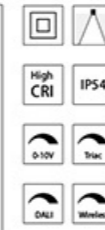
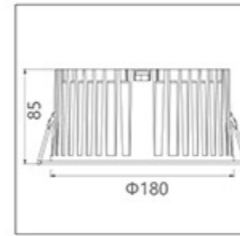

LED brand:
SANAN

CCT:
2700K/3000K/4000K

CRI:
Ra>90

Size:
Φ180x85

Material:
aluminum

Power:
45W

Voltage & Current:
36V

Cutout:
Φ170

Beam angle:
50°

Mains voltage:
220-240V 50/60Hz

Description:
Downlight

Luminousflux:
5000LM



RAIN CURTAIN



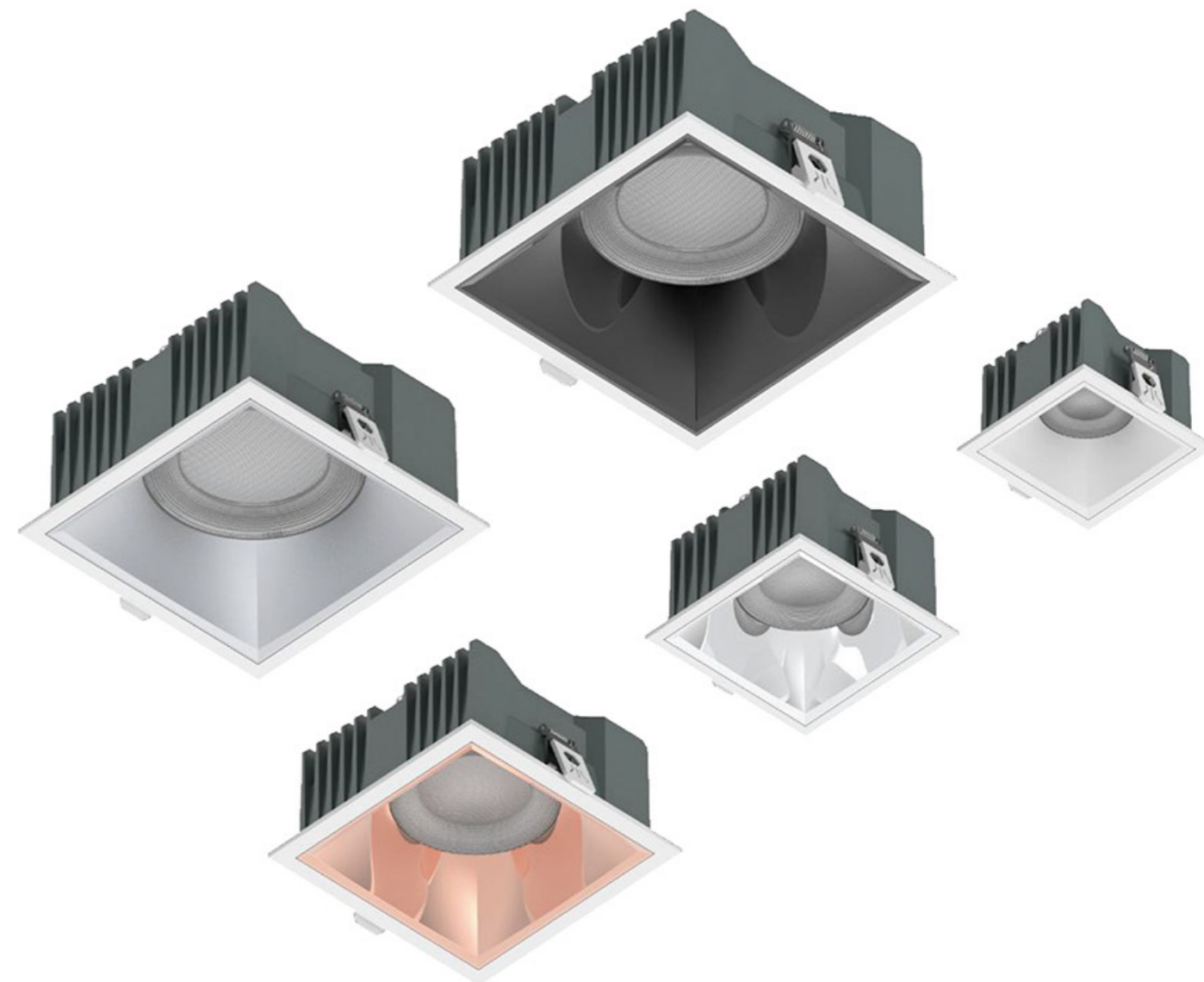

FANG TONG

This series stable and dignified, but simple and elegant.
Multiple color options, perfect combination of lighting and
decoration, 50° ,
Just the right wide Angle for softer and more uniform
lighting.

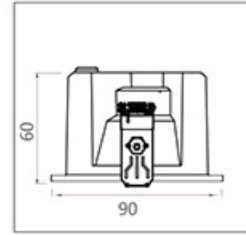

LED brand:
SANAN

CCT:
2700K/3000K/4000K

CRI:
Ra>90

Size:
90x90x60

Material:
aluminum

Power:
12W

Voltage & Current:
36V

Cutout:
75x75

Beam angle:
50°

Mains voltage:
220-240V 50/60Hz

Description:
Downlight

Luminousflux:
1200LM

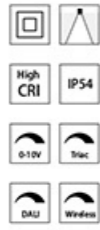
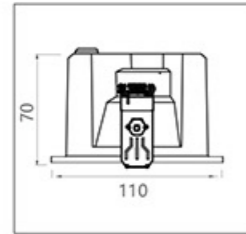

LED brand:
SANAN

CCT:
2700K/3000K/4000K

CRI:
Ra>90

Size:
110x110x70

Material:
aluminum

Power:
20W

Voltage & Current:
36V

Cutout:
95x95

Beam angle:
50°

Mains voltage:
220-240V 50/60Hz

Description:
Downlight

Luminousflux:
2000LM

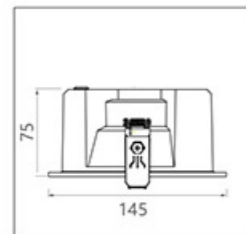

LED brand:
SANAN

CCT:
2700K/3000K/4000K

CRI:
Ra>90

Size:
145x145x75

Material:
aluminum

Power:
30W

Voltage & Current:
36V

Cutout:
125x125

Beam angle:
50°

Mains voltage:
220-240V 50/60Hz

Description:
Downlight

Luminousflux:
2900LM

Matt black Matt white Matt silver Gun black Shiny silver

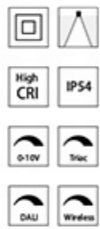
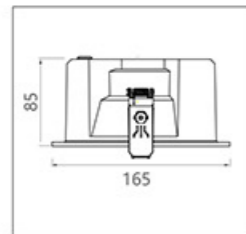

LED brand:
SANAN

CCT:
2700K/3000K/4000K

CRI:
Ra>90

Size:
165x165x85

Material:
aluminum

Power:
36W

Voltage & Current:
36V

Cutout:
145x145

Beam angle:
50°

Mains voltage:
220-240V 50/60

Description:
Downlight

Luminousflux:
3900LM

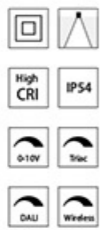
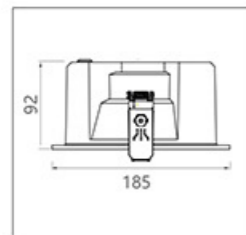

LED brand:
SANAN

CCT:
2700K/3000K/4000K

CRI:
Ra>90

Size:
185x185x92

Material:
aluminum

Power:
45W

Voltage & Current:
36V

Cutout:
165x165

Beam angle:
50°

Mains voltage:
220-240V 50/60

Description:
Downlight

Luminousflux:
5000LM

Matt black Matt white Matt silver Gun black Shiny silver



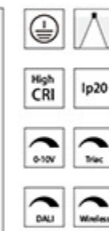
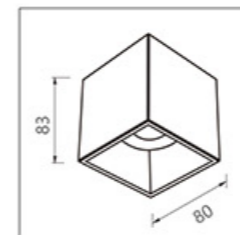
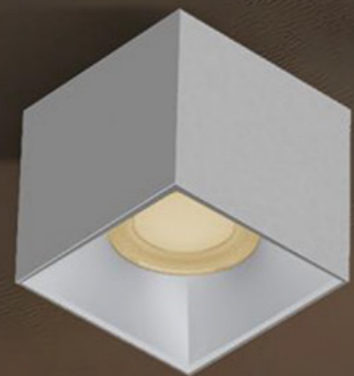

LED brand:
SANAN

CCT:
2700K/3000K/4000K

CRI:
Ra>90

Size:
80x80x83

Material:
aluminum

Power:
12W

Voltage & Current:
36V

Cutout:
/

Beam angle:
50°

Mains voltage:
220-240V 50/60Hz

Description:
Downlight

Luminousflux:
1200LM

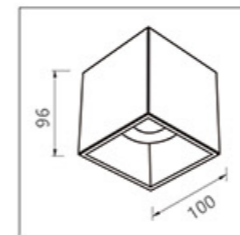

LED brand:
SANAN

CCT:
2700K/3000K/4000K

CRI:
Ra>90

Size:
100x100x96

Material:
aluminum

Power:
20W

Voltage & Current:
36V

Cutout:
/

Beam angle:
50°

Mains voltage:
220-240V 50/60Hz

Description:
Downlight

Luminousflux:
2000LM

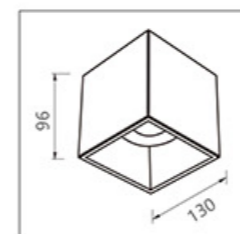

LED brand:
SANAN

CCT:
2700K/3000K/4000K

CRI:
Ra>90

Size:
130x130x96

Material:
aluminum

Power:
30W

Voltage & Current:
36V

Cutout:
/

Beam angle:
50°

Mains voltage:
220-240V 50/60Hz

Description:
Downlight

Luminousflux:
2900LM

Matt black Matt white Matt silver Gun black Shiny silver

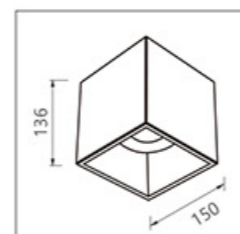

LED brand:
SANAN

CCT:
2700K/3000K/4000K

CRI:
Ra>90

Size:
150x150x136

Material:
aluminum

Power:
36W

Voltage & Current:
36V

Cutout:
/

Beam angle:
50°

Mains voltage:
220-240V 50/60Hz

Description:
Downlight

Luminousflux:
3900LM

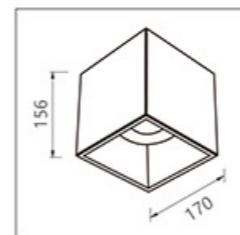

LED brand:
SANAN

CCT:
2700K/3000K/4000K

CRI:
Ra>90

Size:
170x170x136

Material:
aluminum

Power:
45W

Voltage & Current:
36V

Cutout:
/

Beam angle:
50°

Mains voltage:
220-240V 50/60Hz

Description:
Downlight

Luminousflux:
5000LM

Matt black Matt white Matt silver Gun black Shiny silver

MONOLOGUE

Take light as a poem, let the lamp into the darkness,
leaving only a bunch of "self-expression"
The design is to make the lamp disappear and make the
light become the monologue of the space.



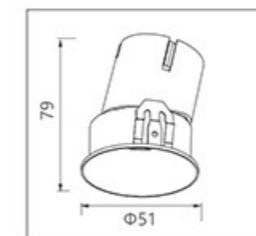

LED brand:
OSRAM

CCT:
2700K/3000K/4000K

CRI:
Ra>90

Size:
Φ51x79

Material:
aluminum

Power:
5W

Voltage & Current:
36V

Cutout:
Φ45

Beam angle:
24°/36°

Mains voltage:
220-240V 50/60Hz

Description:
Downlight

Luminousflux:
300LM

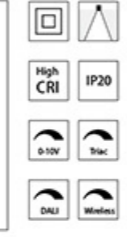
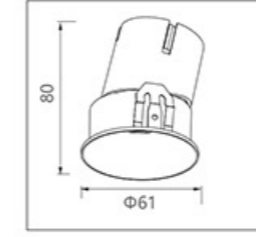

LED brand:
OSRAM

CCT:
2700K/3000K/4000K

CRI:
Ra>90

Size:
Φ61x80

Material:
aluminum

Power:
7W

Voltage & Current:
36V

Cutout:
Φ55

Beam angle:
24°/36°

Mains voltage:
220-240V 50/60Hz

Description:
Downlight

Luminousflux:
400LM

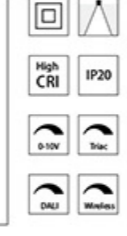
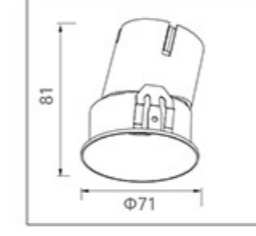

LED brand:
OSRAM

CCT:
2700K/3000K/4000K

CRI:
Ra>90

Size:
Φ71x81

Material:
aluminum

Power:
9W

Voltage & Current:
36V

Cutout:
Φ65

Beam angle:
24°/36°

Mains voltage:
220-240V 50/60Hz

Description:
Downlight

Luminousflux:
600LM

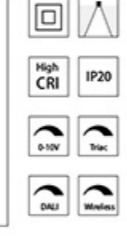
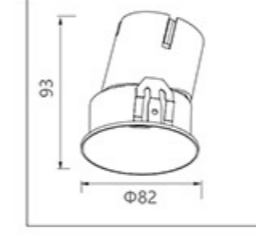

LED brand:
OSRAM

CCT:
2700K/3000K/4000K

CRI:
Ra>90

Size:
Φ82x93

Material:
aluminum

Power:
12W

Voltage & Current:
36V

Cutout:
Φ75

Beam angle:
24°/36°

Mains voltage:
220-240V 50/60Hz

Description:
Downlight

Luminousflux:
800LM

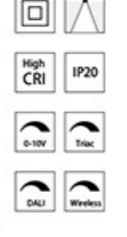
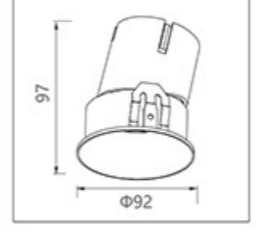

LED brand:
OSRAM

CCT:
2700K/3000K/4000K

CRI:
Ra>90

Size:
Φ92x97

Material:
aluminum

Power:
15W

Voltage & Current:
36V

Cutout:
Φ85

Beam angle:
24°/36°

Mains voltage:
220-240V 50/60Hz

Description:
Downlight

Luminousflux:
930LM

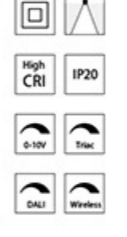
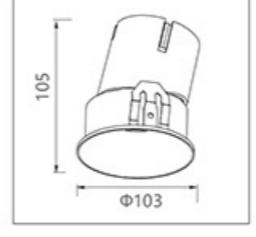

LED brand:
OSRAM

CCT:
2700K/3000K/4000K

CRI:
Ra>90

Size:
Φ103x105

Material:
aluminum

Power:
20W

Voltage & Current:
36V

Cutout:
Φ95

Beam angle:
24°/36°

Mains voltage:
220-240V 50/60Hz

Description:
Downlight

Luminousflux:
1400LM



white



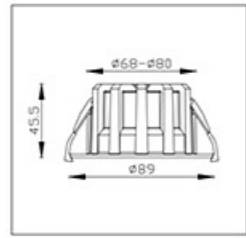

LED brand: SANAN
CCT: 2700K/3000K/4000K
CRI: Ra>90
Size: $\Phi 89 \times 45$

Material: aluminum
Power: 12W
Voltage & Current: 36V
Cutout: $\Phi 75$

Beam angle: 55°
Mains voltage: 220-240V 50/60Hz
Description: Downlight
Luminousflux: 1300LM

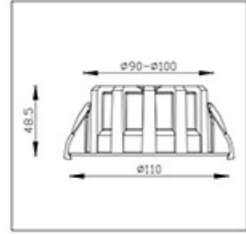

LED brand: SANAN
CCT: 2700K/3000K/4000K
CRI: Ra>90
Size: $\Phi 110 \times 48$

Material: aluminum
Power: 20W
Voltage & Current: 36V
Cutout: $\Phi 95$

Beam angle: 70°
Mains voltage: 220-240V 50/60Hz
Description: Downlight
Luminousflux: 2300LM

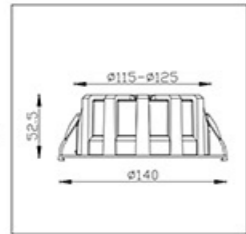

LED brand: SANAN
CCT: 2700K/3000K/4000K
CRI: Ra>90
Size: $\Phi 140 \times 52$

Material: aluminum
Power: 30W
Voltage & Current: 36V
Cutout: $\Phi 125$

Beam angle: 80°
Mains voltage: 220-240V 50/60Hz
Description: Downlight
Luminousflux: 3300LM

● Matt black ● Matt white ● Gun black ● Shiny silver

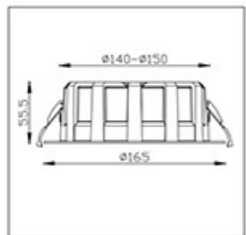

LED brand: SANAN
CCT: 2700K/3000K/4000K
CRI: Ra>90
Size: $\Phi 165 \times 52$

Material: aluminum
Power: 35W
Voltage & Current: 36V
Cutout: $\Phi 145$

Beam angle: 85°
Mains voltage: 220-240V 50/60Hz
Description: Downlight
Luminousflux: 4000LM

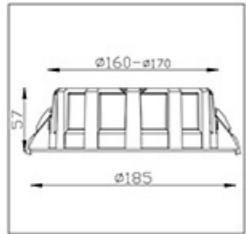

LED brand: SANAN
CCT: 2700K/3000K/4000K
CRI: Ra>90
Size: $\Phi 185 \times 57$

Material: aluminum
Power: 40W
Voltage & Current: 36V
Cutout: $\Phi 165$

Beam angle: 90°
Mains voltage: 220-240V 50/60Hz
Description: Downlight
Luminousflux: 5000LM

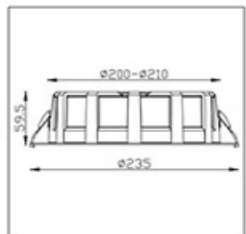

LED brand: SANAN
CCT: 2700K/3000K/4000K
CRI: Ra>90
Size: $\Phi 235 \times 59$

Material: aluminum
Power: 45W
Voltage & Current: 36V
Cutout: $\Phi 200$

Beam angle: 90°
Mains voltage: 220-240V 50/60Hz
Description: Downlight
Luminousflux: 5900LM

● Matt black ● Matt white ● Gun black ● Shiny silver





REVERBERATE

Patterns of light "reverberate" through space
As a dialogue between space and light, "reverberation" is born : not a single light,
It is a two-way resonance between light and architecture, people and environment.
Da36 series products are very rich, simple fashion style, designed different kinds of light,
3.5W to 12W power, suitable for different lighting needs, mask square, round,
The lamp design suitable for different levels. Meet the high requirements of the lighting scene.

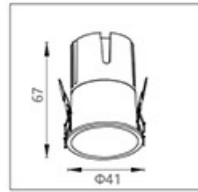

LED brand:
OSRAM
CCT:
2700K/3000K/4000K
CRI:
Ra>90
Size:
Φ41x67

Material: aluminum
Power: 3.5W
Voltage & Current: 36V
Cutout: Φ35
Beam angle: 24°/36°
Mains voltage: 220-240V 50/60Hz
Description: Downlight
Luminousflux: 230LM

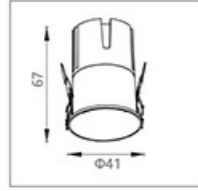

LED brand:
OSRAM
CCT:
2700K/3000K/4000K
CRI:
Ra>90
Size:
Φ41x67

Material: aluminum
Power: 3.5W
Voltage & Current: 36V
Cutout: Φ35
Beam angle: 24°/36°
Mains voltage: 220-240V 50/60Hz
Description: Downlight
Luminousflux: 230LM

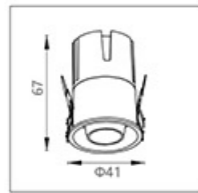

LED brand:
OSRAM
CCT:
2700K/3000K/4000K
CRI:
Ra>90
Size:
Φ41x67

Material: aluminum
Power: 3.5W
Voltage & Current: 36V
Cutout: Φ35
Beam angle: 24°/36°
Mains voltage: 220-240V 50/60Hz
Description: Downlight
Luminousflux: 200LM

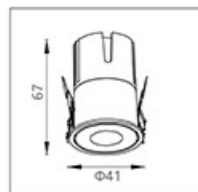

LED brand:
OSRAM
CCT:
2700K/3000K/4000K
CRI:
Ra>90
Size:
Φ41x67

Material: aluminum
Power: 3.5W
Voltage & Current: 36V
Cutout: Φ35
Beam angle: 24°/36°
Mains voltage: 220-240V 50/60Hz
Description: Downlight
Luminousflux: 180LM

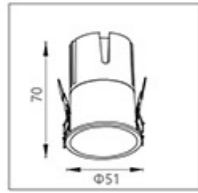

LED brand:
OSRAM
CCT:
2700K/3000K/4000K
CRI:
Ra>90
Size:
Φ51x70

Material: aluminum
Power: 5W
Voltage & Current: 36V
Cutout: Φ45
Beam angle: 24°/36°
Mains voltage: 220-240V 50/60Hz
Description: Downlight
Luminousflux: 350LM

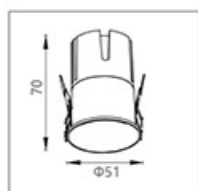

LED brand:
OSRAM
CCT:
2700K/3000K/4000K
CRI:
Ra>90
Size:
Φ51x70

Material: aluminum
Power: 5W
Voltage & Current: 36V
Cutout: Φ45
Beam angle: 24°/36°
Mains voltage: 220-240V 50/60Hz
Description: Downlight
Luminousflux: 350LM

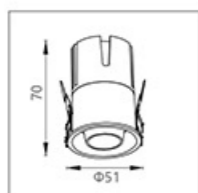

LED brand:
OSRAM
CCT:
2700K/3000K/4000K
CRI:
Ra>90
Size:
Φ51x70

Material: aluminum
Power: 5W
Voltage & Current: 36V
Cutout: Φ45
Beam angle: 24°/36°
Mains voltage: 220-240V 50/60Hz
Description: Downlight
Luminousflux: 280LM

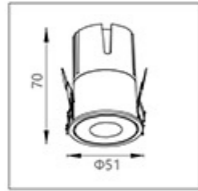

LED brand:
OSRAM
CCT:
2700K/3000K/4000K
CRI:
Ra>90
Size:
Φ51x70

Material: aluminum
Power: 5W
Voltage & Current: 36V
Cutout: Φ45
Beam angle: 24°/36°
Mains voltage: 220-240V 50/60Hz
Description: Downlight
Luminousflux: 230LM



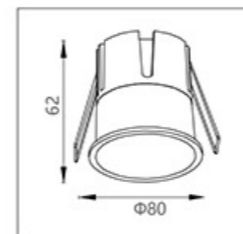

LED brand:
OSRAM

CCT:
2700K/3000K/4000K

CRI:
Ra>90

Size:
Φ80x62

● black ○ white ● white+black

Material:
aluminum

Power:
12W

Voltage & Current:
36V

Cutout:
Φ75

Beam angle:
24°/36°

Mains voltage:
220-240V 50/60Hz

Description:
Downlight

Luminousflux:
900LM

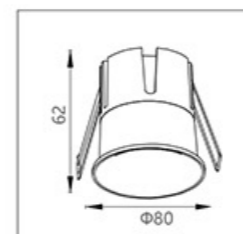

LED brand:
OSRAM

CCT:
2700K/3000K/4000K

CRI:
Ra>90

Size:
Φ80x62

● black ○ white ● Plating color

Material:
aluminum

Power:
12W

Voltage & Current:
36V

Cutout:
Φ75

Beam angle:
24°/36°

Mains voltage:
220-240V 50/60Hz

Description:
Downlight

Luminousflux:
900LM

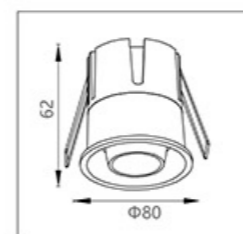

LED brand:
OSRAM

CCT:
2700K/3000K/4000K

CRI:
Ra>90

Size:
Φ80x62

● black ○ white ● white+black

Material:
aluminum

Power:
12W

Voltage & Current:
36V

Cutout:
Φ75

Beam angle:
24°/36°

Mains voltage:
220-240V 50/60Hz

Description:
Downlight

Luminousflux:
700LM

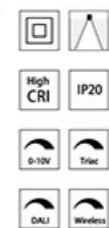
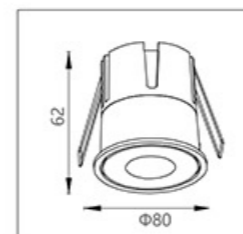

LED brand:
OSRAM

CCT:
2700K/3000K/4000K

CRI:
Ra>90

Size:
Φ80x62

● black ○ white ● white+black

Material:
aluminum

Power:
12W

Voltage & Current:
36V

Cutout:
Φ75

Beam angle:
24°/36°

Mains voltage:
220-240V 50/60Hz

Description:
Downlight

Luminousflux:
700LM

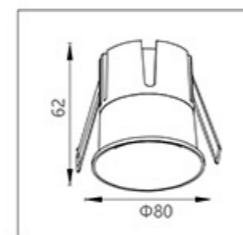

LED brand:
OSRAM

CCT:
2700K/3000K/4000K

CRI:
Ra>90

Size:
Φ80x62

● black ○ white ● white+black

Material:
aluminum

Power:
12W

Voltage & Current:
36V

Cutout:
Φ75

Beam angle:
24°/36°

Mains voltage:
220-240V 50/60Hz

Description:
Downlight

Luminousflux:
900LM

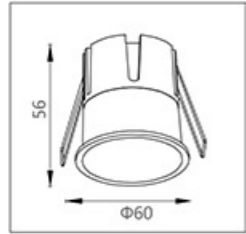

LED brand:
OSRAM

CCT:
2700K/3000K/4000K

CRI:
Ra > 90

Size:
Φ60X56

● black ○ white ● white+black

Material:
aluminum

Power:
7W

Voltage & Current:
36V

Cutout:
Φ55

Beam angle:
24°/36°

Mains voltage:
220-240V 50/60Hz

Description:
Downlight

Luminousflux:
480LM

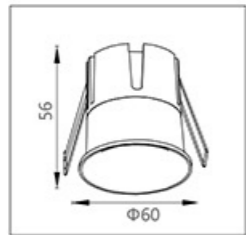

LED brand:
OSRAM

CCT:
2700K/3000K/4000K

CRI:
Ra > 90

Size:
Φ60X56

● black ○ white ● Plating color

Material:
aluminum

Power:
7W

Voltage & Current:
36V

Cutout:
Φ55

Beam angle:
24°/36°

Mains voltage:
220-240V 50/60Hz

Description:
Downlight

Luminousflux:
480LM

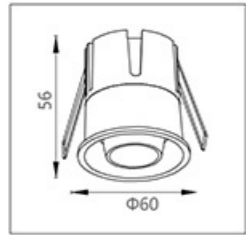

LED brand:
OSRAM

CCT:
2700K/3000K/4000K

CRI:
Ra > 90

Size:
Φ60X56

● black ○ white ● white+black

Material:
aluminum

Power:
7W

Voltage & Current:
36V

Cutout:
Φ55

Beam angle:
24°/36°

Mains voltage:
220-240V 50/60Hz

Description:
Downlight

Luminousflux:
230LM

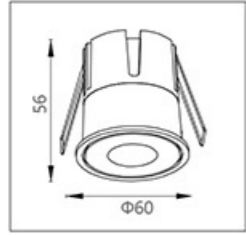

LED brand:
OSRAM

CCT:
2700K/3000K/4000K

CRI:
Ra > 90

Size:
Φ60X56

● black ○ white ● white+black

Material:
aluminum

Power:
7W

Voltage & Current:
36V

Cutout:
Φ55

Beam angle:
24°/36°

Mains voltage:
220-240V 50/60Hz

Description:
Downlight

Luminousflux:
230LM





REVERBERATE



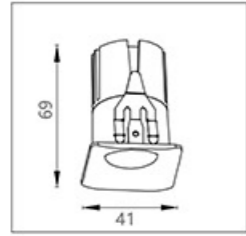

LED brand: OSRAM
CCT: 2700K/3000K/4000K
CRI: Ra>90
Size: 41x41x69

Material: aluminum
Power: 3.5W
Voltage & Current: 36V
Cutout: Φ 35

● black ○ white
Beam angle: 24°/36°
Mains voltage: 220-240V 50/60Hz
Description: Downlight
Luminousflux: 230LM

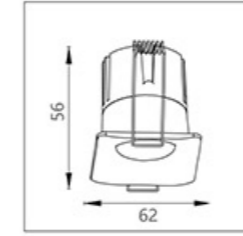

LED brand: OSRAM
CCT: 2700K/3000K/4000K
CRI: Ra>90
Size: 62x62x56

Material: aluminum
Power: 7W
Voltage & Current: 36V
Cutout: Φ 55

● black ○ white
Beam angle: 24°/36°
Mains voltage: 220-240V 50/60Hz
Description: Downlight
Luminousflux: 450LM

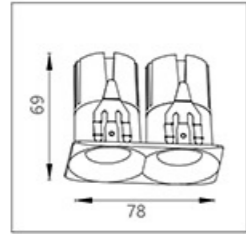

LED brand: OSRAM
CCT: 2700K/3000K/4000K
CRI: Ra>90
Size: 41x78x69

Material: aluminum
Power: 3.5Wx2
Voltage & Current: 36V
Cutout: 35*68

● black ○ white
Beam angle: 24°/36°
Mains voltage: 220-240V 50/60Hz
Description: Downlight
Luminousflux: 230LM*2

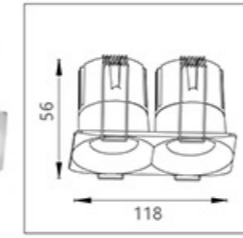

LED brand: OSRAM
CCT: 2700K/3000K/4000K
CRI: Ra>90
Size: 62x118x56

Material: aluminum
Power: 7Wx2
Voltage & Current: 36V
Cutout: 55x103

● black ○ white
Beam angle: 24°/36°
Mains voltage: 220-240V 50/60Hz
Description: Downlight
Luminousflux: 450LM*2

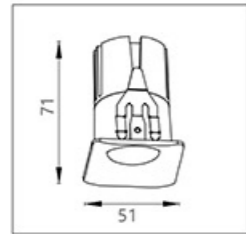

LED brand: OSRAM
CCT: 2700K/3000K/4000K
CRI: Ra>90
Size: 51x51x71

Material: aluminum
Power: 5W
Voltage & Current: 36V
Cutout: Φ 45

● black ○ white
Beam angle: 24°/36°
Mains voltage: 220-240V 50/60Hz
Description: Downlight
Luminousflux: 350LM

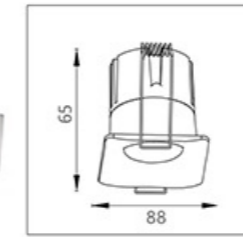

LED brand: OSRAM
CCT: 2700K/3000K/4000K
CRI: Ra>90
Size: 88x88x65

Material: aluminum
Power: 12W
Voltage & Current: 36V
Cutout: Φ 75

● black ○ white
Beam angle: 24°/36°
Mains voltage: 220-240V 50/60Hz
Description: Downlight
Luminousflux: 900LM

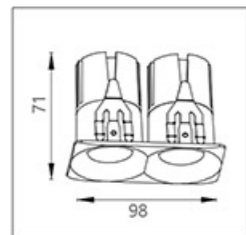

LED brand: OSRAM
CCT: 2700K/3000K/4000K
CRI: Ra>90
Size: 51x98x71

Material: aluminum
Power: 5Wx2
Voltage & Current: 36V
Cutout: 45x88

● black ○ white
Beam angle: 24°/36°
Mains voltage: 220-240V 50/60Hz
Description: Downlight
Luminousflux: 350LM*2

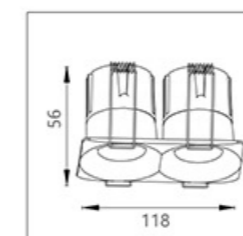

LED brand: OSRAM
CCT: 2700K/3000K/4000K
CRI: Ra>90
Size: 62x118x56

Material: aluminum
Power: 12Wx2
Voltage & Current: 36V
Cutout: 75x141

● black ○ white
Beam angle: 24°/36°
Mains voltage: 220-240V 50/60Hz
Description: Downlight
Luminousflux: 900LM*2

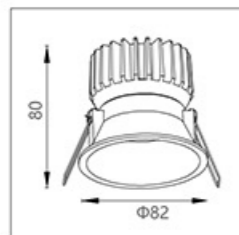

LED brand: OSRAM
CCT: 2700K/3000K/4000K
CRI: Ra>90
Size: Φ82x80

Material: aluminum
Power: 12W
Voltage & Current: 36V
Cutout: Φ75
Beam angle: 24°/36°
Mains voltage: 220-240V 50/60Hz
Description: Downlight
Luminousflux: 820LM

● black ○ white ◐ white+black

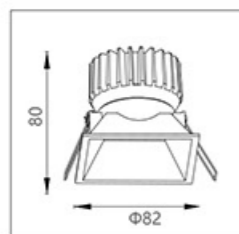

LED brand: OSRAM
CCT: 2700K/3000K/4000K
CRI: Ra>90
Size: 82x82x80

Material: aluminum
Power: 12W
Voltage & Current: 36V
Cutout: 75x75
Beam angle: 24°/36°
Mains voltage: 220-240V 50/60Hz
Description: Downlight
Luminousflux: 820LM

● black ○ white ◐ white+black

This series breaking through physical boundaries with technology, Let each light have both power and temperature.[™]
Extremely narrow frame, simple fashion, 12W high power suitable for more space
High heat dissipation, more durable lamps.

MICROFLAME



MULTI TRACK

Magnet track lighting is an innovative and stylish lighting system that offers flexibility and elegance. With its magnetic rail, fixtures can be easily adjusted and repositioned, making it perfect for modern homes, offices, and retail spaces.

Key Benefits:

- Sleek and minimalistic design
- Easy installation and adjustable fixtures
- Energy-efficient LED options
- Perfect for accent, task, and ambient lighting

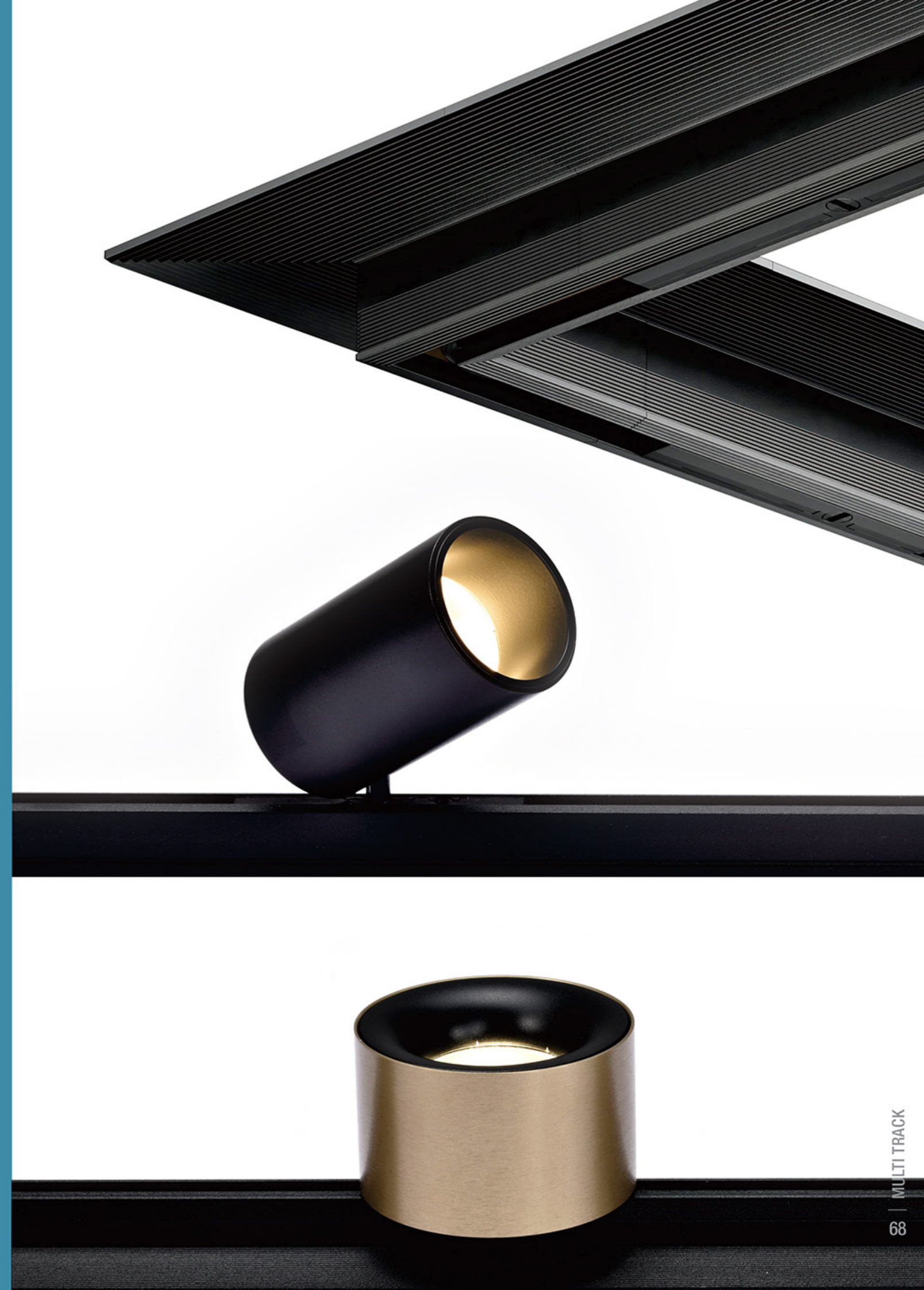

W05MAGNETSYSTEMseries

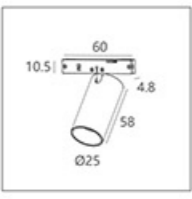



High CRI
IP20
355°
90°

LightSource: LED
Luminousflux: 180lm
CRi: Ra>90
CCT: 2700K/3000K/4000K/5000K

Material: Aluminum
Power: 3W
Outputvoltage: 3V
Outputcurrent: 700mA

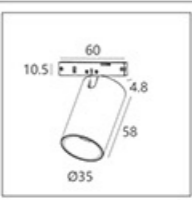
OPTIC: 15°/24°/36°
Mainsvoltage: DC24V
Description: Magnetic rail spotlight
Cutout: /





High CRI
IP20
355°
90°

LightSource: COB
Luminousflux: 500lm
CRi: Ra>90
CCT: 2700K/3000K/4000K/5000K

Material: Aluminum
Power: 5W
Outputvoltage: 36V
Outputcurrent: 120mA

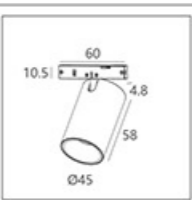
OPTIC: 15°/24°/36°
Mainsvoltage: DC24V
Description: Magnetic rail spotlight
Cutout: /

High CRI
IP20
355°
90°

LightSource: COB
Luminousflux: 700lm
CRi: Ra>90
CCT: 2700K/3000K/4000K/5000K

Material: Aluminum
Power: 9W
Outputvoltage: 36V
Outputcurrent: 200mA

OPTIC: 15°/24°/36°
Mainsvoltage: DC24V
Description: Magnetic rail spotlight
Cutout: /

COLORS



WRT Track (Flush mounting)

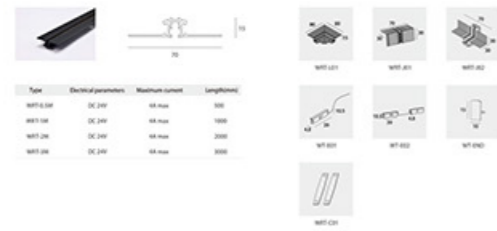

Type	Electrical parameters	Maximum current	Length(m)
WRT-01	DC 24V	4A max	300
WRT-02	DC 24V	4A max	1000
WRT-03	DC 24V	4A max	2000
WRT-04	DC 24V	4A max	3000

WDT Track (CLAMP PLATE)

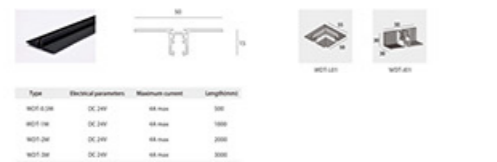

Type	Electrical parameters	Maximum current	Length(m)
WDT-01	DC 24V	4A max	300
WDT-02	DC 24V	4A max	1000
WDT-03	DC 24V	4A max	2000
WDT-04	DC 24V	4A max	3000

WST Track (Surface mounting)



Type	Electrical parameters	Maximum current	Length(m)
WST-01	DC 24V	4A max	300
WST-02	DC 24V	4A max	1000
WST-03	DC 24V	4A max	2000
WST-04	DC 24V	4A max	3000

WST Track (Surface mounting)

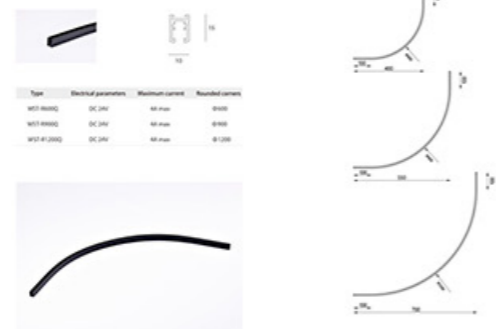

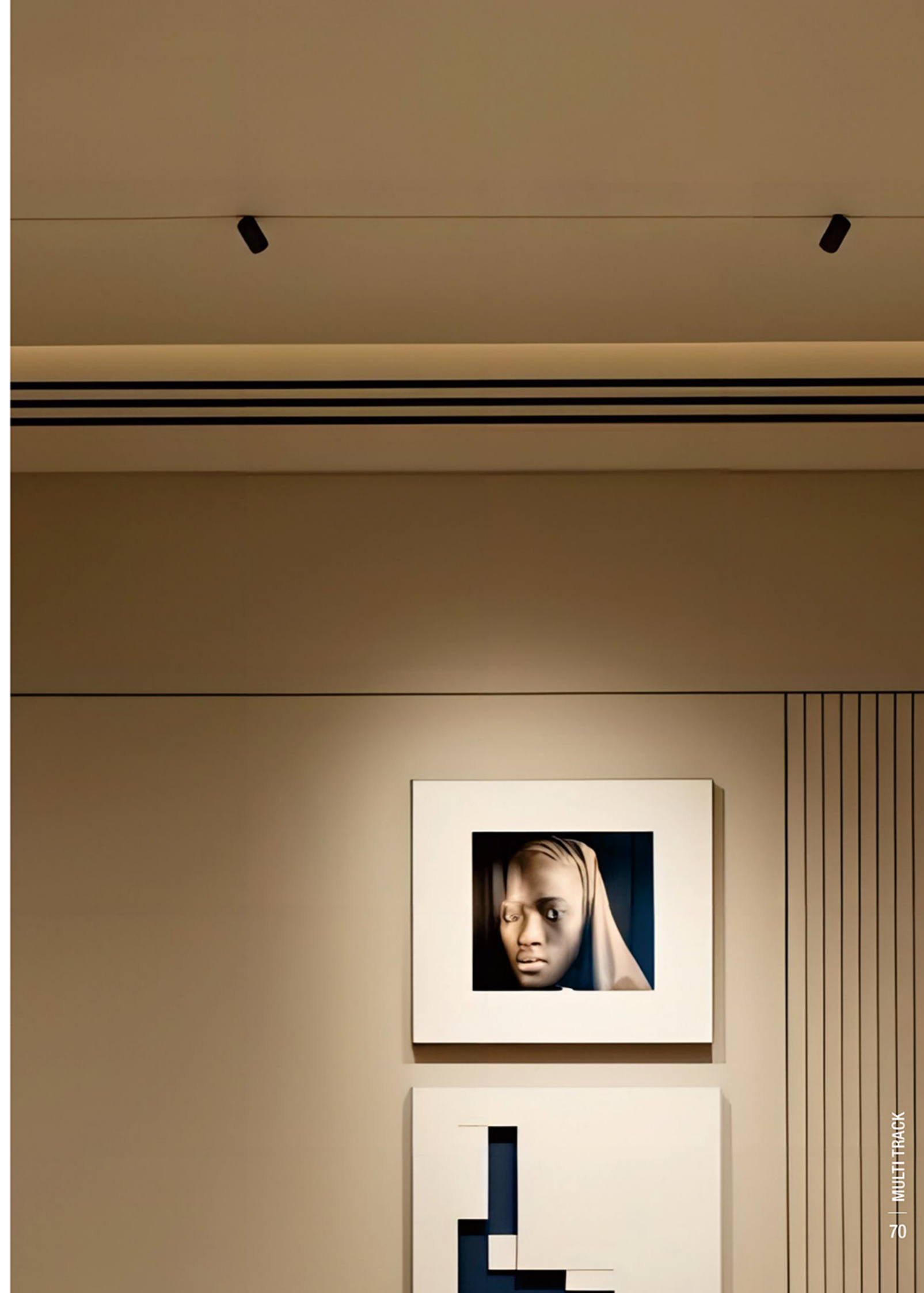

Type	Electrical parameters	Maximum current	Maximal current
WST-01	DC 24V	4A max	4000
WST-02	DC 24V	4A max	4000
WST-03	DC 24V	4A max	4000



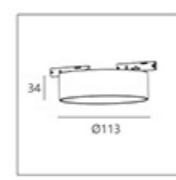

W05MAGNETSYSTEMseries

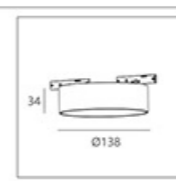
			LightSource: LED Luminousflux: 700lm CR: Ra>80 CCT: 2700K/3000K/4000K/5000K	Material: Aluminum Power: 8W Outputvoltage: 24V Outputcurrent: /	OPTIC: 100° Mainsvoltage: DC24V Description: Magneticsuction Cutout: /
			LightSource: LED Luminousflux: 1100lm CR: Ra>80 CCT: 2700K/3000K/4000K/5000K	Material: Aluminum Power: 12W Outputvoltage: 24V Outputcurrent: /	OPTIC: 100° Mainsvoltage: DC24V Description: Magneticsuction Cutout: /

COLORS
 ● BK ● WH ● GY



W05MAGNETSYSTEMseries

			<p>LightSource: LED</p> <p>Luminousflux: 700lm</p> <p>CRI: Ra>80</p> <p>CCT: 2700K/3000K/4000K/5000K</p>	<p>Material: Aluminum</p> <p>Power: 8W</p> <p>Outputvoltage: 24V</p> <p>Outputcurrent: /</p>	<p>OPTIC: 100°</p> <p>Mainsvoltage: DC24V</p> <p>Description: Magneticsuction</p> <p>Cutout: /</p>
			<p>LightSource: LED</p> <p>Luminousflux: 1100lm</p> <p>CRI: Ra>80</p> <p>CCT: 2700K/3000K/4000K/5000K</p>	<p>Material: Aluminum</p> <p>Power: 12W</p> <p>Outputvoltage: 24V</p> <p>Outputcurrent: /</p>	<p>OPTIC: 100°</p> <p>Mainsvoltage: DC24V</p> <p>Description: Magneticsuction</p> <p>Cutout: /</p>
			<p>LightSource: LED</p> <p>Luminousflux: 1300lm</p> <p>CRI: Ra>80</p> <p>CCT: 2700K/3000K/4000K/5000K</p>	<p>Material: Aluminum</p> <p>Power: 16W</p> <p>Outputvoltage: 24V</p> <p>Outputcurrent: /</p>	<p>OPTIC: 100°</p> <p>Mainsvoltage: DC24V</p> <p>Description: Magneticsuction</p> <p>Cutout: /</p>
			<p>LightSource: LED</p> <p>Luminousflux: 2300lm</p> <p>CRI: Ra>80</p> <p>CCT: 2700K/3000K/4000K/5000K</p>	<p>Material: Aluminum</p> <p>Power: 24W</p> <p>Outputvoltage: 24V</p> <p>Outputcurrent: /</p>	<p>OPTIC: 100°</p> <p>Mainsvoltage: DC24V</p> <p>Description: Magneticsuction</p> <p>Cutout: /</p>

COLORS



EXTREMELY
SLIM
DESIGN



		LightSource: LED	Material: Aluminum+PC	OPTIC: 100°
		Luminousflux: 450lm	Power: 5W	Mainsvoltage: DC24V
		CRI: Ra>80	Outputvoltage: 24V	Description: Magneticsuction
		CCT: 2700K/3000K/4000K/5000K	Outputcurrent: /	Cutout: /

		LightSource: LED	Material: Aluminum+PC	OPTIC: 100°
		Luminousflux: 900lm	Power: 10W	Mainsvoltage: DC24V
		CRI: Ra>80	Outputvoltage: 24V	Description: Magneticsuction
		CCT: 2700K/3000K/4000K/5000K	Outputcurrent: /	Cutout: /

		LightSource: LED	Material: Aluminum+PC	OPTIC: 100°
		Luminousflux: 1300lm	Power: 15W	Mainsvoltage: DC24V
		CRI: Ra>80	Outputvoltage: 24V	Description: Magneticsuction
		CCT: 2700K/3000K/4000K/5000K	Outputcurrent: /	Cutout: /

COLORS



BK

WDT

WST

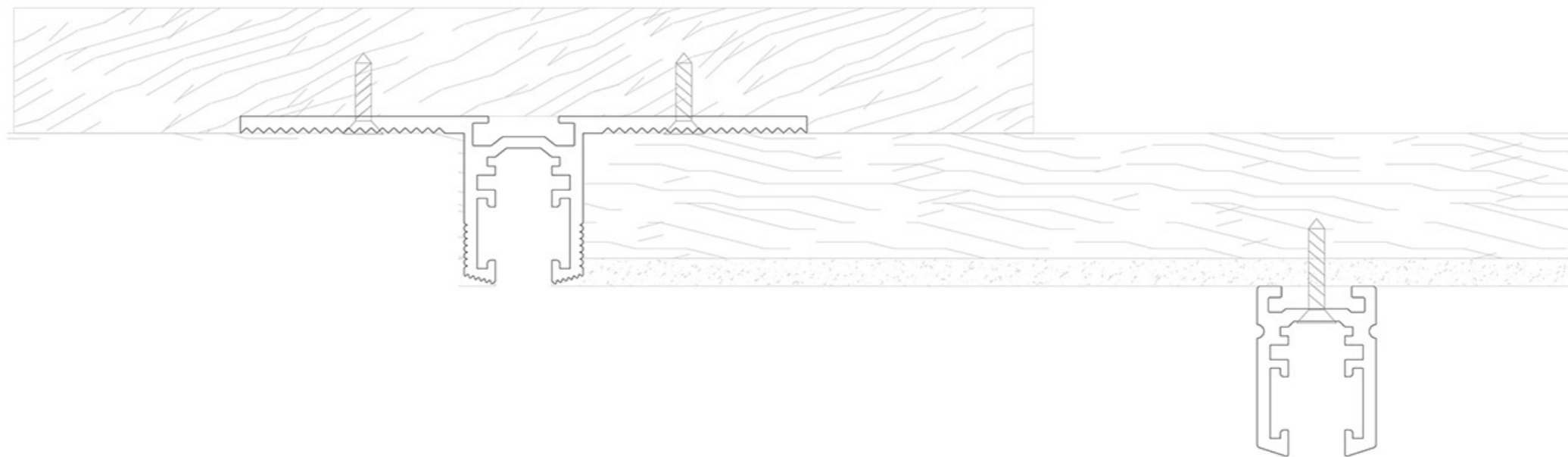

WST

WDT

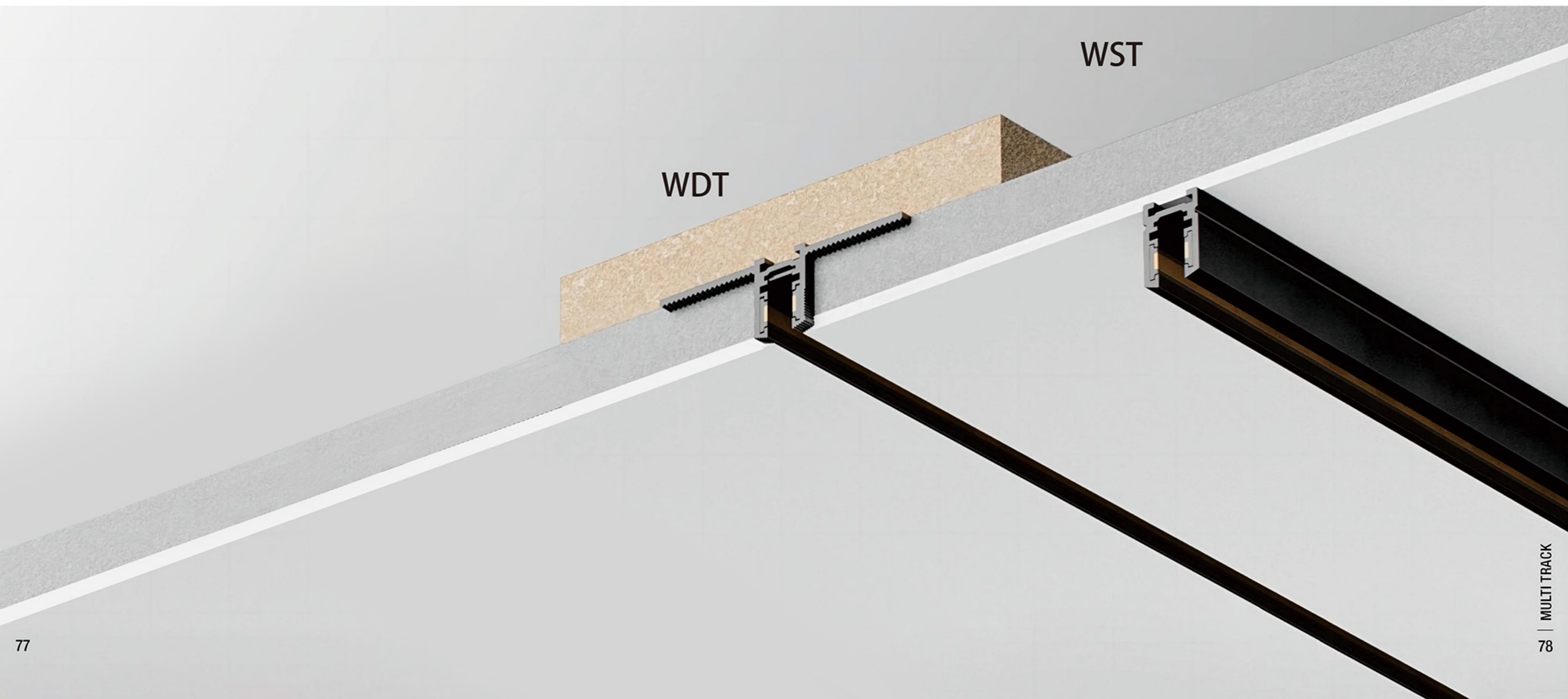

W05MAGNETSYSTEMseries

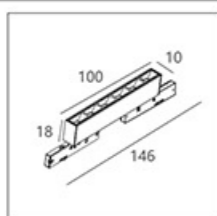

LightSource:
LED

Luminousflux:
500lm

CRI:
Ra>90

CCT:
2700K/3000K/4000K/5000K

Material:
Aluminum

Power:
6W

Outputvoltage:
24V

Outputcurrent:
/

OPTIC:
15°/24°/36°

Mainsvoltage:
DC24V

Description:
Magneticsuction

Cutout:
/

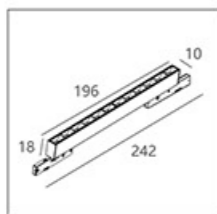

LightSource:
LED

Luminousflux:
1100lm

CRI:
Ra>90

CCT:
2700K/3000K/4000K/5000K

Material:
Aluminum

Power:
12W

Outputvoltage:
24V

Outputcurrent:
/

OPTIC:
15°/24°/36°

Mainsvoltage:
DC24V

Description:
Magneticsuction

Cutout:
/

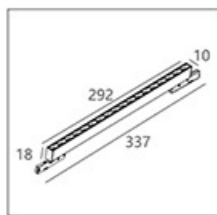

LightSource:
LED

Luminousflux:
1600lm

CRI:
Ra>90

CCT:
2700K/3000K/4000K/5000K

Material:
Aluminum

Power:
18W

Outputvoltage:
24V

Outputcurrent:
/

OPTIC:
15°/24°/36°

Mainsvoltage:
DC24V

Description:
Magneticsuction

Cutout:
/



LightSource:
LED

Luminousflux:
2300lm

CRI:
Ra>90

CCT:
2700K/3000K/4000K/5000K

Material:
Aluminum

Power:
24W

Outputvoltage:
24V

Outputcurrent:
/

OPTIC:
15°/24°/36°

Mainsvoltage:
DC24V

Description:
Magneticsuction

Cutout:
/

COLORS



BK





MAGNETSYSTEMseries



1000

LightSource:
LED

Luminousflux:
/

CRI:
Ra>80

CCT:
3000K

Material:
Silicone

Power:
10W

Outputvoltage:
24V

Outputcurrent:
/

OPTIC:
100°

Mainsvoltage:
DC24V

Description:
Light Strip

Cutout:
/



2000

LightSource:
LED

Luminousflux:
/

CRI:
Ra>80

CCT:
3000K

Material:
Silicone

Power:
20W

Outputvoltage:
24V

Outputcurrent:
/

OPTIC:
100°

Mainsvoltage:
DC24V

Description:
Light Strip

Cutout:
/

COLORS





FLEXIBLE TRACK

Flexible Track Lights are a modern and adaptable lighting system that allows users to adjust the direction and placement of light as desired. These lights typically consist of a bendable track that can be shaped into various forms, making them ideal for highlighting specific areas, creating decorative lighting effects, and enhancing the ambiance of residential, commercial, or gallery spaces. Thanks to their flexibility, they offer a stylish and functional solution for dynamic lighting designs. Many models also come with adjustable brightness and color options, providing even greater customization.

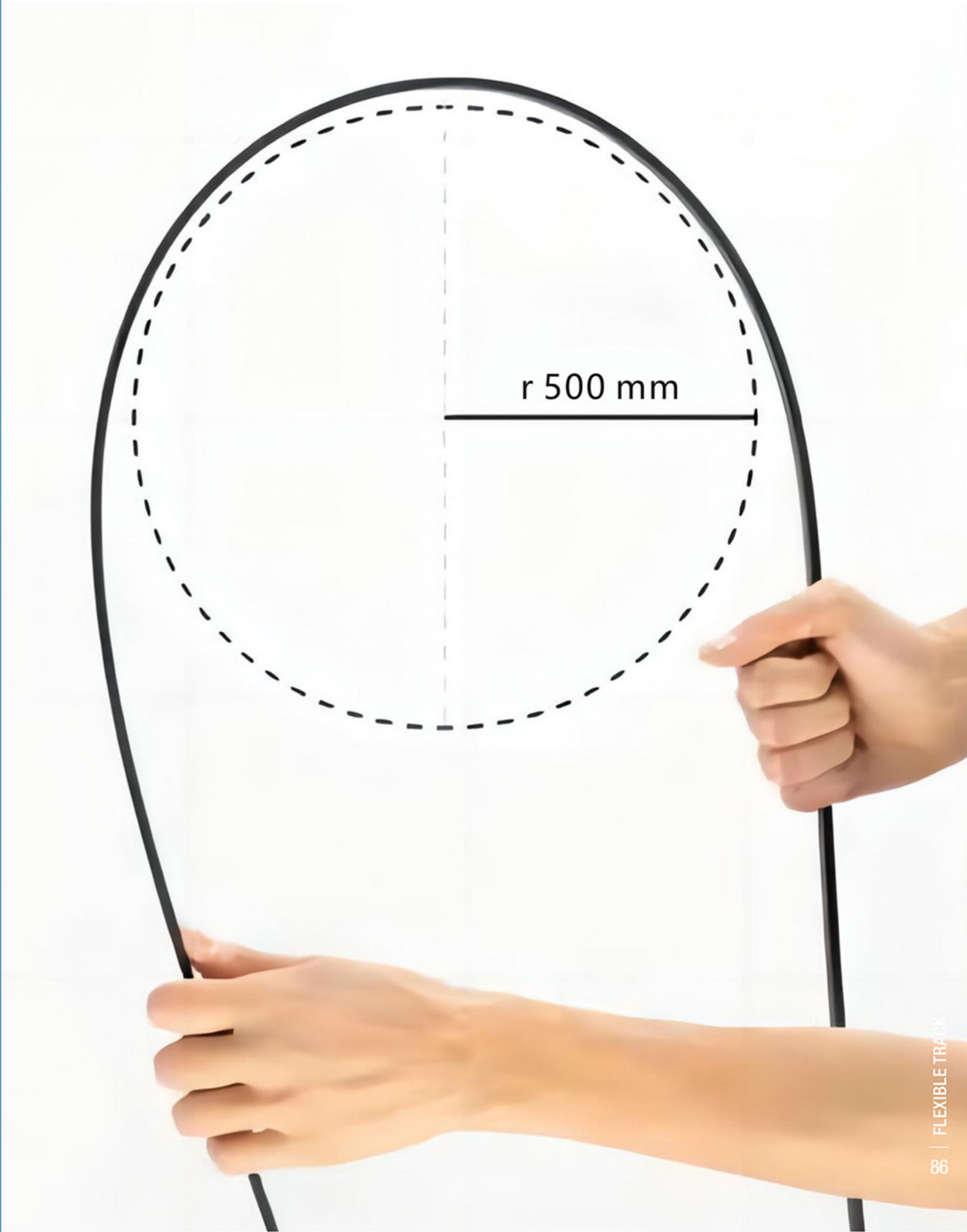



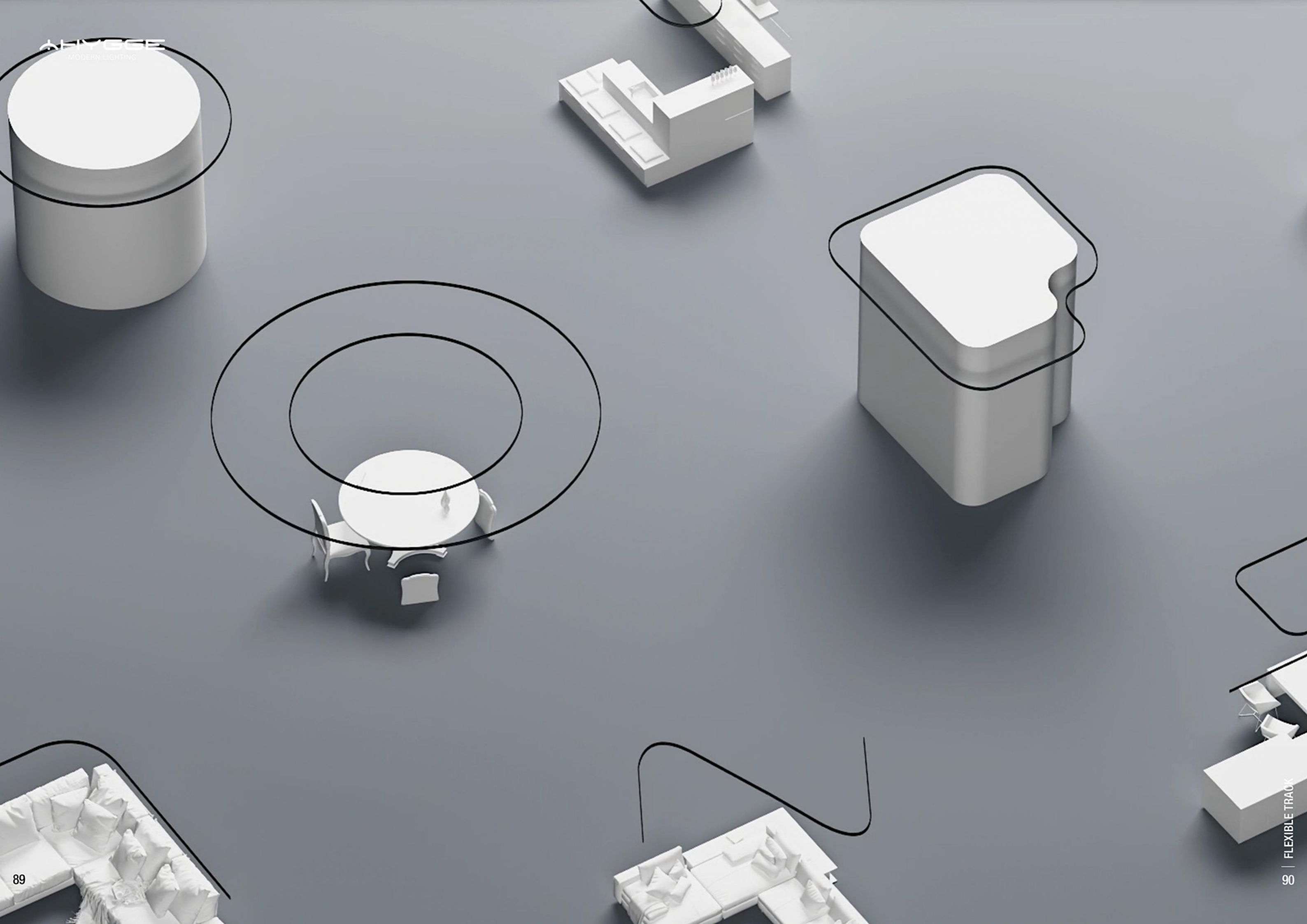

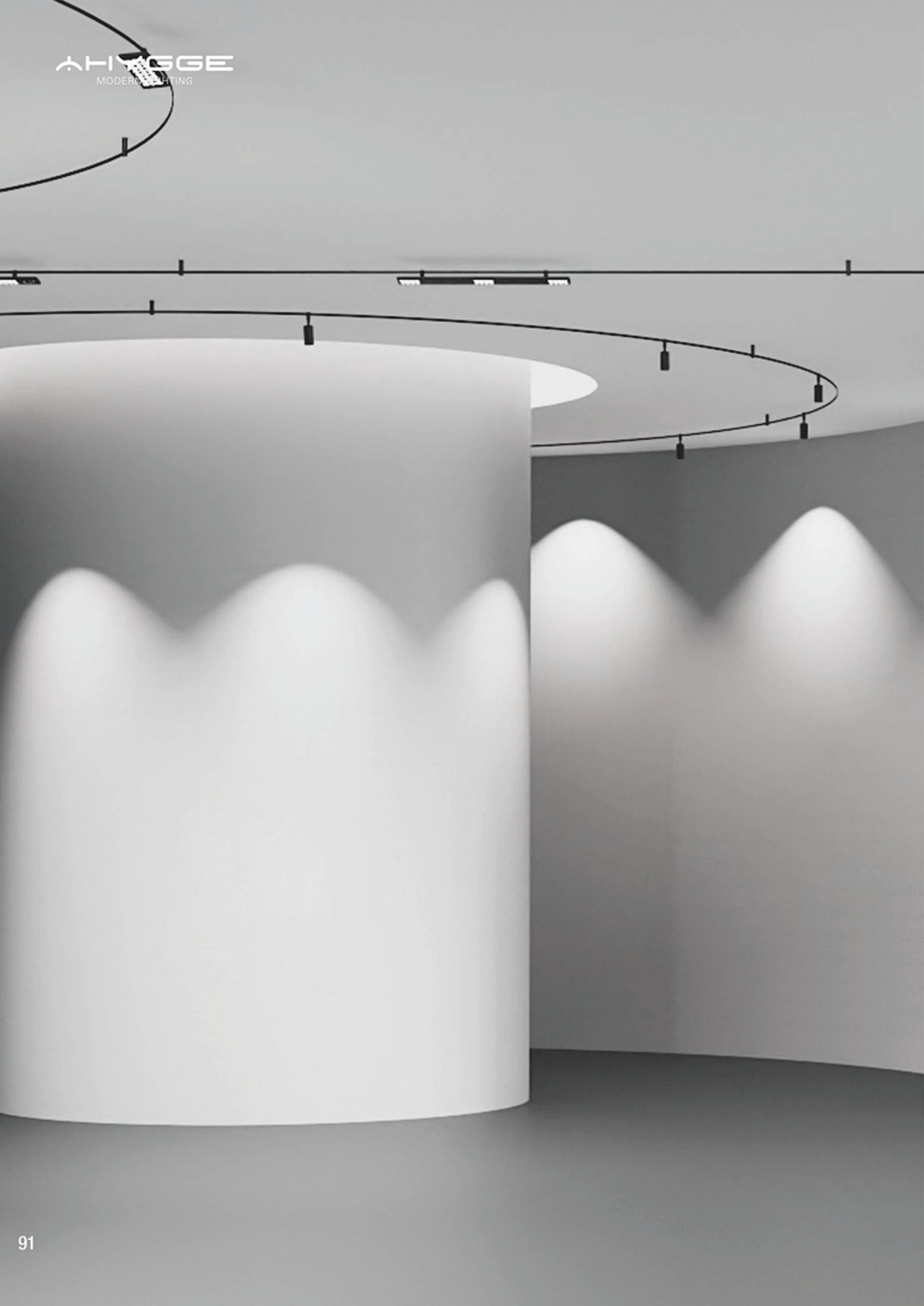





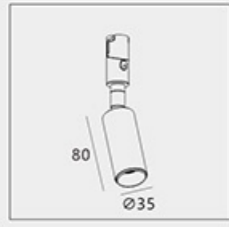

LightSource:
COB

CCT:
2700K/3000K/4000K/5000K

Input(V):
48V

Voltage & Current:
36V 150mA

Size:
Ø35*80mm

Power:
7W

Material:
Aluminium

OPTIC:
15°/24°/36°

CRI:
Ra>90

Description:
Track Spotlight

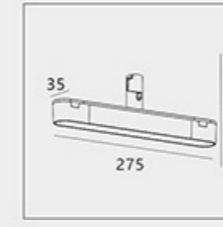

LightSource:
LED

CCT:
2700K/3000K/4000K/5000K

Input(V):
48V

Voltage & Current:
48V

Size:
275*35*85mm

Power:
10W

Material:
Aluminium

OPTIC:
100°

CRI:
Ra>90

Description:
Fixed floodlights



LightSource:
COB

CCT:
2700K/3000K/4000K/5000K

Input(V):
48V

Voltage & Current:
36V 250mA

Size:
Ø45*100mm

Power:
10W

Material:
Aluminium

OPTIC:
15°/24°/36°

CRI:
Ra>90

Description:
Track Spotlight

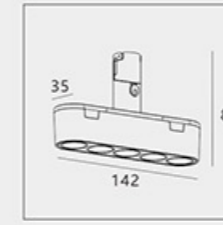

LightSource:
LED

CCT:
2700K/3000K/4000K/5000K

Input(V):
48V

Voltage & Current:
48V

Size:
142*35*85 mm

Power:
5W

Material:
Aluminium

OPTIC:
24°

CRI:
Ra>90

Description:
Fixed grille light



LightSource:
COB

CCT:
2700K/3000K/4000K/5000K

Input(V):
48V

Voltage & Current:
36V 350mA

Size:
Ø60*120mm

Power:
15W

Material:
Aluminium

OPTIC:
15°/24°/36°

CRI:
Ra>90

Description:
Track Spotlight

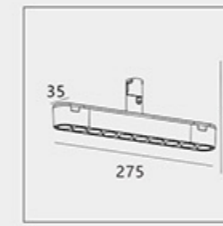

LightSource:
LED

CCT:
2700K/3000K/4000K/5000K

Input(V):
48V

Voltage & Current:
48V

Size:
270*35*85 mm

Power:
10W

Material:
Aluminium

OPTIC:
24°

CRI:
Ra>90

Description:
Fixed grille light

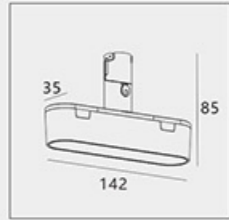

LightSource:
LED

CCT:
2700K/3000K/4000K/5000K

Input(V):
48V

Voltage & Current:
48V

Size:
142*35*85mm

Power:
5W

Material:
Aluminium

OPTIC:
100°

CRI:
Ra>90

Description:
Fixed floodlights

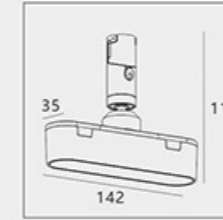

LightSource:
LED

CCT:
2700K/3000K/4000K/5000K

Input(V):
48V

Voltage & Current:
48V

Size:
142*35*117mm

Power:
5W

Material:
Aluminium

OPTIC:
100°

CRI:
Ra>90

Description:
Swivel Floodlight

COLORS







BK

COLORS

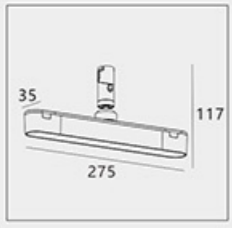

BK









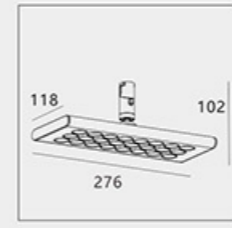

LightSource:
LED
CCT:
2700K/3000K/4000K/5000K
Input(V):
48V
Voltage & Current:
48V

Size:
275*35*117mm
Power:
10W
Material:
Aluminium

OPTIC:
100°
CRI:
Ra>90
Description:
Swivel Floodlight









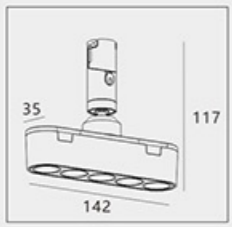

LightSource:
LED
CCT:
2700K/3000K/4000K/5000K
Input(V):
48V
Voltage & Current:
48V

Size:
276*118*102mm
Power:
24W
Material:
Aluminium

OPTIC:
60°/90°
CRI:
Ra>90
Description:
Shaker Grille Lamp









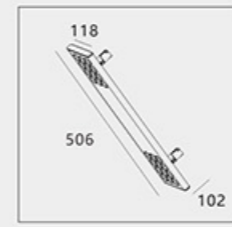

LightSource:
LED
CCT:
2700K/3000K/4000K/5000K
Input(V):
48V
Voltage & Current:
48V

Size:
142*35*117 mm
Power:
5W
Material:
Aluminium

OPTIC:
24°
CRI:
Ra>90
Description:
Shaker Grille Lamp









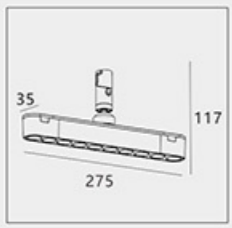

LightSource:
LED
CCT:
2700K/3000K/4000K/5000K
Input(V):
48V
Voltage & Current:
48V

Size:
506*118*102 mm
Power:
12W*2
Material:
Aluminium

OPTIC:
60°/90°
CRI:
Ra>90
Description:
Fixed grille light without backlight











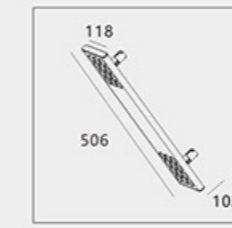

LightSource:
LED
CCT:
2700K/3000K/4000K/5000K
Input(V):
48V
Voltage & Current:
48V

Size:
270*35*117 mm
Power:
10W
Material:
Aluminium

OPTIC:
24°
CRI:
Ra>90
Description:
Shaker Grille Lamp











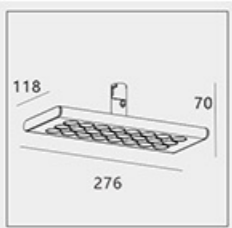

LightSource:
LED
CCT:
2700K/3000K/4000K/5000K
Input(V):
48V
Voltage & Current:
48V

Size:
506*118*102mm
Power:
Downward LED 12W*2
Upper LED 8W
Material:
Aluminium

OPTIC:
60°/90°
CRI:
Ra>90
Description:
Backlit Fixed Grille Lamp

LightSource:
LED
CCT:
2700K/3000K/4000K/5000K
Input(V):
48V
Voltage & Current:
48V

Size:
276*118*70mm
Power:
24W
Material:
Aluminium

OPTIC:
60°/90°
CRI:
Ra>90
Description:
Fixed grille light







LightSource:
LED
CCT:
2700K/3000K/4000K/5000K
Input(V):
48V
Voltage & Current:
48V

Size:
1006*118*70 mm
Power:
18W*2
Material:
Aluminium

OPTIC:
60°/90°
CRI:
Ra>90
Description:
Fixed grille light without backlight

COLORS



BK

COLORS



BK

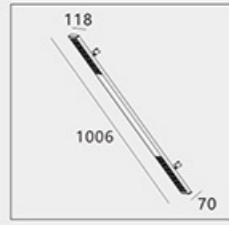

LightSource:
LED

CCT:
2700K/3000K/4000K/5000K

Input(V):
48V

Voltage & Current:
48V

Size:
1006*118*70 mm

Power:
Downward LED 18W*2
Upper LED 15W

Material:
Aluminium

OPTIC:
60°/90°

CRI:
Ra>90

Description:
Backlit Fixed Grille Lamp

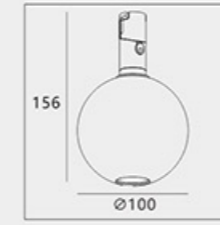

LightSource:
LED

CCT:
2700K/3000K/4000K/5000K

Input(V):
48V

Voltage & Current:
48V

Size:
Ø100*156 mm

Power:
5W

Material:
Glass

OPTIC:
100°

CRI:
Ra>90

Description:
Fixed

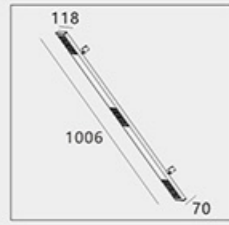

LightSource:
LED

CCT:
2700K/3000K/4000K/5000K

Input(V):
48V

Voltage & Current:
48V

Size:
1006*118*70 mm

Power:
12W*3

Material:
Aluminium

OPTIC:
60°/90°

CRI:
Ra>90

Description:
Fixed grille light
without backlight



LightSource:
LED

CCT:
2700K/3000K/4000K/5000K

Input(V):
48V

Voltage & Current:
48V

Size:
Ø118*131mm

Power:
5W

Material:
Glass

OPTIC:
100°

CRI:
Ra>90

Description:
Fixed



LightSource:
LED

CCT:
2700K/3000K/4000K/5000K

Input(V):
48V

Voltage & Current:
48V

Size:
Ø113*87mm

Power:
12W

Material:
Aluminium

OPTIC:
100°

CRI:
Ra>90

Description:
Fixed floodlights



LightSource:
LED

CCT:
2700K/3000K/4000K/5000K

Input(V):
48V

Voltage & Current:
48V

Size:
Ø50*160mm

Power:
3W

Material:
Glass

OPTIC:
100°

CRI:
Ra>90

Description:
Fixed



LightSource:
LED

CCT:
2700K/3000K/4000K/5000K

Input(V):
48V

Voltage & Current:
48V

Size:
Ø138*87mm

Power:
20W

Material:
Aluminium

OPTIC:
100°

CRI:
Ra>90

Description:
Fixed floodlights

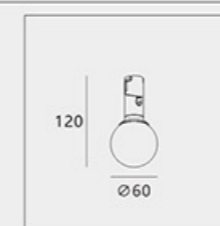

LightSource:
LED

CCT:
2700K/3000K/4000K/5000K

Input(V):
48V

Voltage & Current:
48V

Size:
Ø60*120mm

Power:
3W

Material:
Glass

OPTIC:
200°

CRI:
Ra>90

Description:
Fixed

COLORS



BK

COLORS



WH

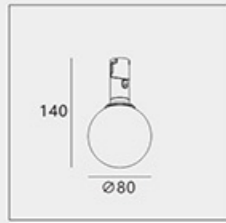

LightSource:
LED

CCT:
2700K/3000K/4000K/5000K

Input(V):
48V

Voltage & Current:
48V

Size:
Ø80*120mm

Power:
3W

Material:
Glass

OPTIC:
200°

CRI:
Ra>90

Description:
Fixed

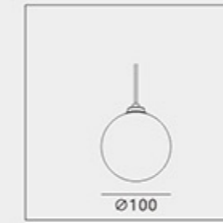

LightSource:
LED

CCT:
2700K/3000K/4000K/5000K

Input(V):
48V

Voltage & Current:
48V

Size:
Ø100 mm

Power:
5W

Material:
Glass

OPTIC:
200°

CRI:
Ra>90

Description:
Chandelier version

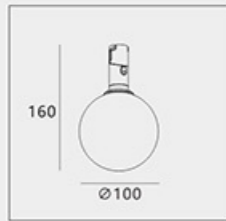

LightSource:
LED

CCT:
2700K/3000K/4000K/5000K

Input(V):
48V

Voltage & Current:
48V

Size:
Ø100*160mm

Power:
5W

Material:
Glass

OPTIC:
200°

CRI:
Ra>90

Description:
Fixed

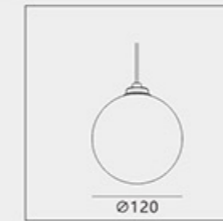

LightSource:
LED

CCT:
2700K/3000K/4000K/5000K

Input(V):
48V

Voltage & Current:
48V

Size:
Ø120mm

Power:
5W

Material:
Glass

OPTIC:
200°

CRI:
Ra>90

Description:
Chandelier version

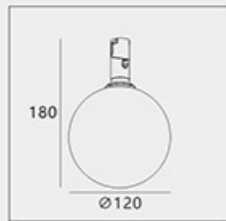

LightSource:
LED

CCT:
2700K/3000K/4000K/5000K

Input(V):
48V

Voltage & Current:
48V

Size:
Ø120*180mm

Power:
5W

Material:
Glass

OPTIC:
200°

CRI:
Ra>90

Description:
Fixed

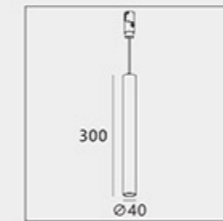

LightSource:
LED

CCT:
2700K/3000K/4000K/5000K

Input(V):
48V

Voltage & Current:
36V 120mA

Size:
Ø40*300 mm

Power:
5W

Material:
Aluminium

OPTIC:
15°/24°/36°

CRI:
Ra>90

Description:
Chandelier version



LightSource:
LED

CCT:
2700K/3000K/4000K/5000K

Input(V):
48V

Voltage & Current:
48V

Size:
Ø60mm

Power:
3W

Material:
Glass

OPTIC:
200°

CRI:
Ra>90

Description:
Chandelier version

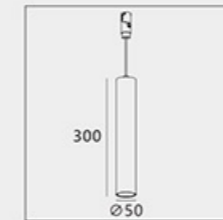

LightSource:
LED

CCT:
2700K/3000K/4000K/5000K

Input(V):
48V

Voltage & Current:
36V 250mA

Size:
Ø50*300 mm

Power:
10W

Material:
Aluminium

OPTIC:
15°/24°/36°

CRI:
Ra>90

Description:
Chandelier version

COLORS



COLORS



MAGNET SYSTEM

Magnet System lights are one of the most modern & flexible lighting systems in interior design. These lights are installed on magnetic tracks, allowing easy positioning and angle adjustment without the need for special tools.

Key features of this system include a minimalist design, energy efficiency, adjustable lighting, and a variety of light types (linear, spot, and pendant lights). They are ideal for residential, commercial, office, and exhibition spaces, providing users with customizable lighting solutions.



MAGNET SYSTEM

ELECTRICAL SAFETY

The low voltage of the track is synonym of electrical safety for the user, permitting greater versatility and ease-of-use, and installation. The luminaires can be installed without having to disconnect the track from the mains, and they can be manipulated directly by hand, without needing any protection means.

This advantage exists because the low voltage of track 48V is lower than the limit beyond which contact with electricity is harmful for the human being. The best technical lighting yield, with zero risks.

EASY-TO-INSTALL

There are few things that are easier to install than a luminaire on an Arkoslight low voltage track.

No tools are required. The product clip system can be gently pressed into the track by hand, where it remains

secured and electrically supplied. As easy as pie. Changing the product location is just as easy as the installation. A gentle pull suffices to remove it from its location, applying the same method as before to install it, as many times as you want.



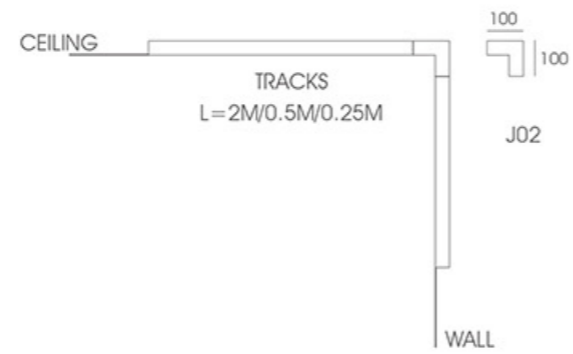
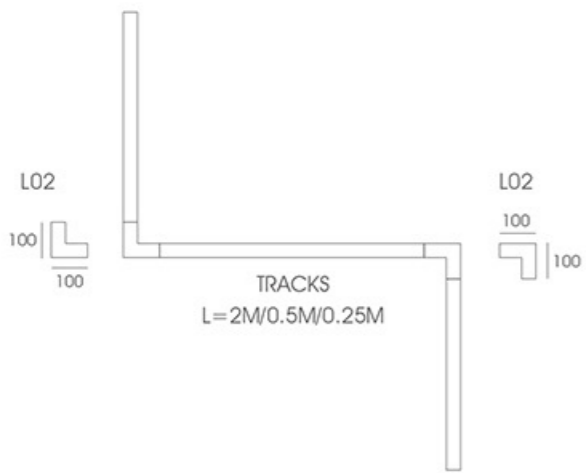
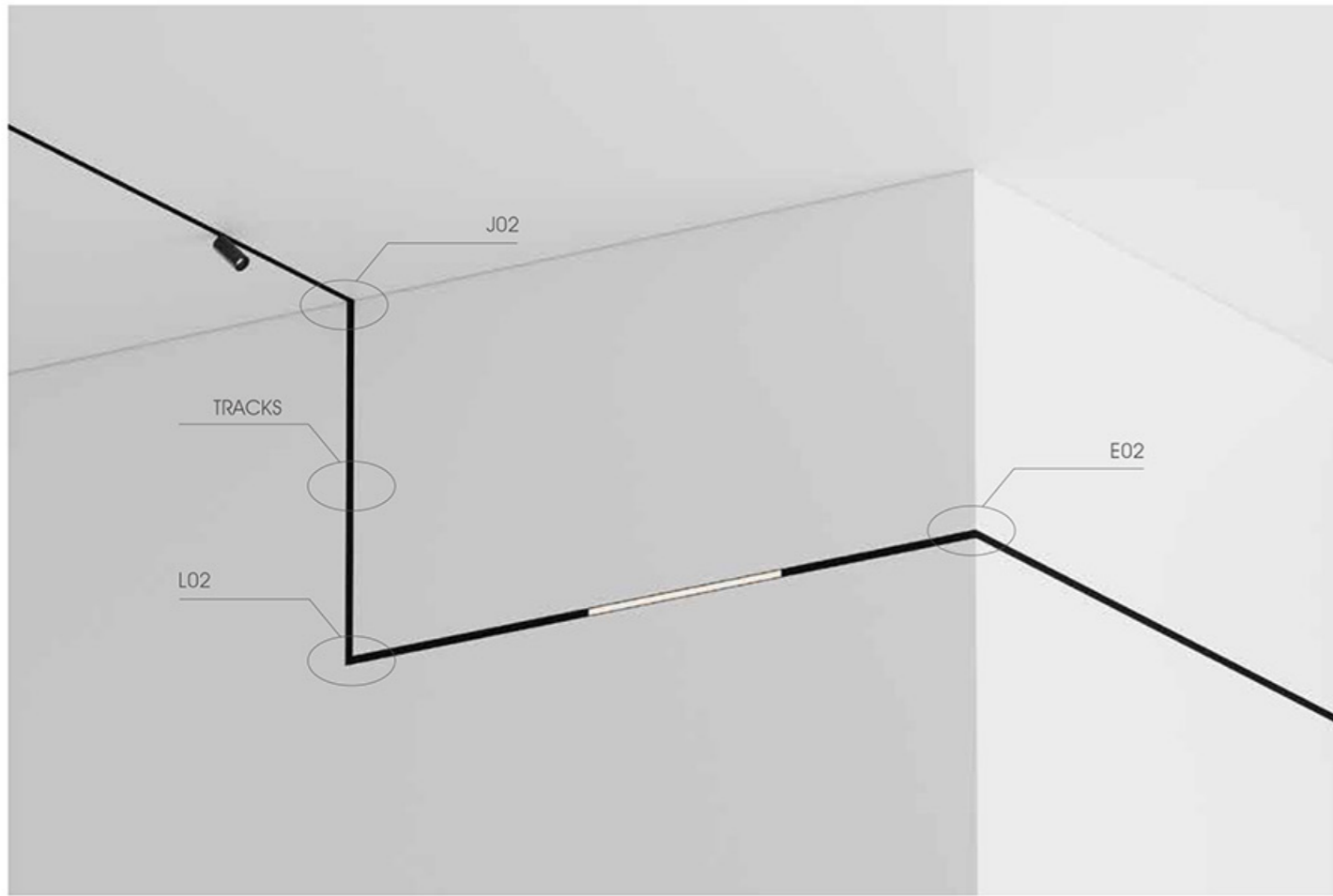

SURFACE MOUNTED / PENDENT



Type	Electrical parameters	Maximum current	Length(mm)
LST-0.25M	DC 24V/DC 48V	4A max	250
LST-0.5M	DC 24V/DC 48V	4A max	500
LST-1M	DC 24V/DC 48V	4A max	1000
LST-2M	DC 24V/DC 48V	4A max	2000

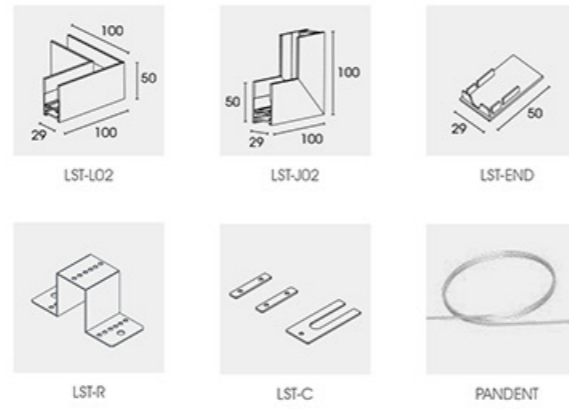

RECESSED / RECESSED(CLAMP PLATE)



Type	Electrical parameters	Maximum current	Length(mm)
LDT-0.25M	DC 24V/DC 48V	4A max	250
LDT-0.5M	DC 24V/DC 48V	4A max	500
LDT-1M	DC 24V/DC 48V	4A max	1000
LDT-2M	DC 24V/DC 48V	4A max	2000

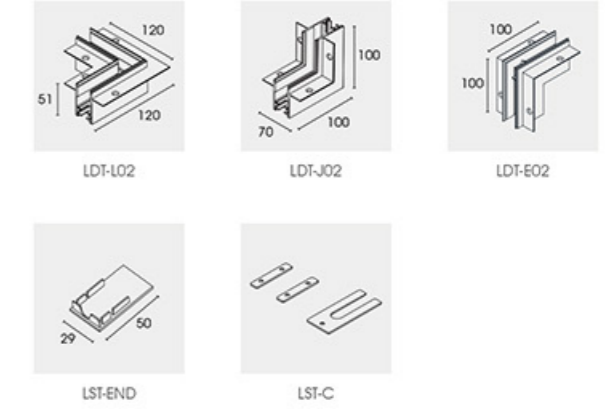

RECESSED / RECESSED(SHRAPNEL)



Type	Electrical parameters	Maximum current	Length(mm)
LTT-0.25M	DC 24V/DC 48V	4A max	250
LTT-0.5M	DC 24V/DC 48V	4A max	500
LTT-1M	DC 24V/DC 48V	4A max	1000
LTT-2M	DC 24V/DC 48V	4A max	2000

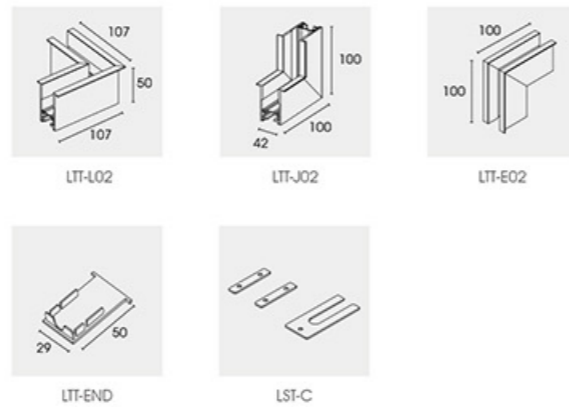

RECESSED / RECESSED(CLAMP PLATE)

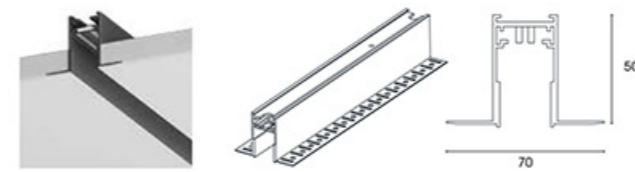

Type	Electrical parameters	Maximum current	Length(mm)
LWT-0.25M	DC 24V/DC 48V	4A max	250
LWT-0.5M	DC 24V/DC 48V	4A max	500
LWT-1M	DC 24V/DC 48V	4A max	1000
LWT-2M	DC 24V/DC 48V	4A max	2000

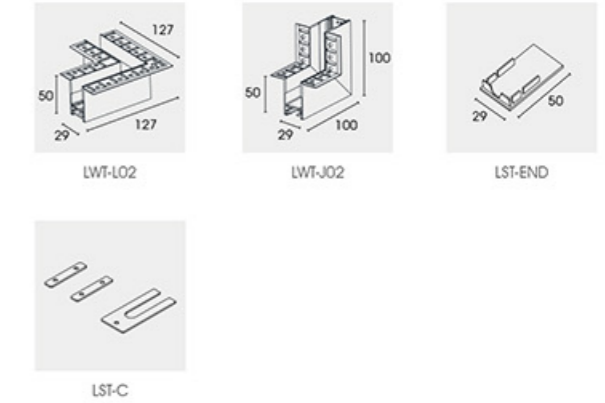

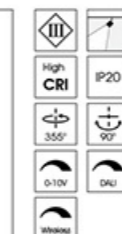
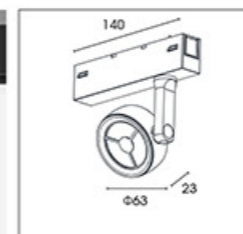

Light Source:
CREE COB

Luminous flux:
500 lm

CRI:
Ra > 90

CCT:
2700K/3000K/4000K/5000K

Material:
Aluminum

Power:
7W

Output voltage:
DC 24V
DC 48V
Output current:
150mA

OPTIC:
12°/20°/30°

Mains voltage:
220-240V 50/60Hz

Description:
Magnetic suction

Cutout:
/

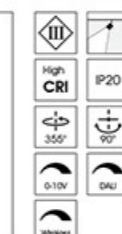
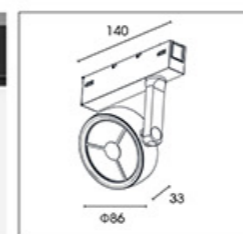
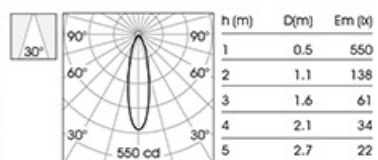
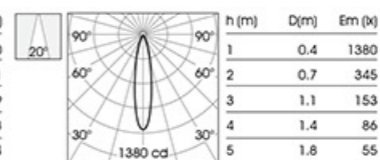
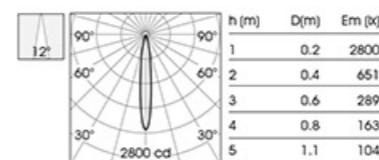

Light Source:
CREE COB

Luminous flux:
700 lm

CRI:
Ra > 90

CCT:
2700K/3000K/4000K/5000K

Material:
Aluminum

Power:
9W

Output voltage:
DC 24V
DC 48V
Output current:
200mA

OPTIC:
12°/20°/30°

Mains voltage:
220-240V 50/60Hz

Description:
Magnetic suction

Cutout:
/

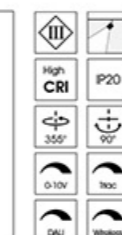
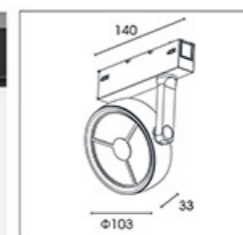
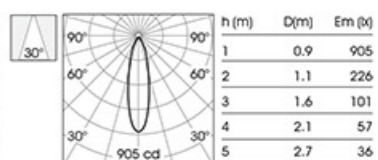
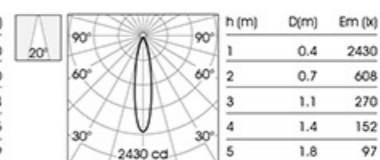
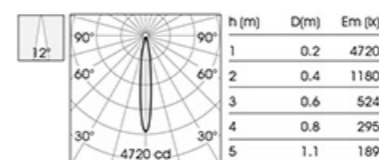

Light Source:
CREE COB

Luminous flux:
1100 lm

CRI:
Ra > 90

CCT:
2700K/3000K/4000K/5000K

Material:
Aluminum

Power:
12W

Output voltage:
DC 24V
DC 48V
Output current:
300mA

OPTIC:
12°/20°/30°

Mains voltage:
220-240V 50/60Hz

Description:
Magnetic suction

Cutout:
/

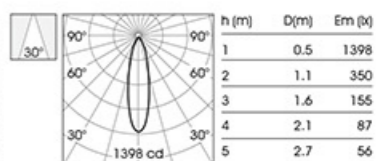
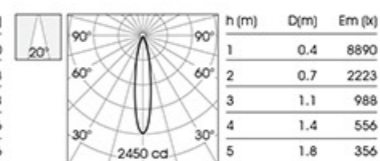
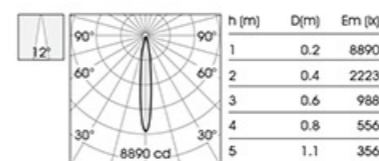

COLORS



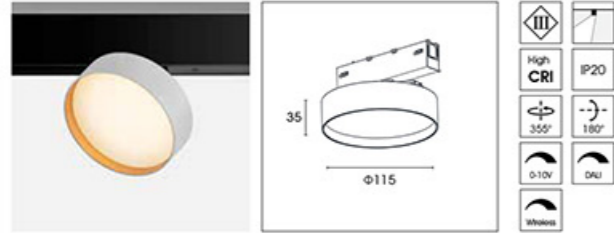

Light Source:
2835 LED

Luminous flux:
1000 lm

CRI:
Ra > 90

CCT:
2700K/3000K/4000K/5000K

Material:
Aluminum

Power:
12W

Output voltage:
DC 24V
DC 48V

Output current:
300mA

OPTIC:
100°

Mains voltage:
220-240V 50/60Hz

Description:
Magnetic suction

Cutout:
/

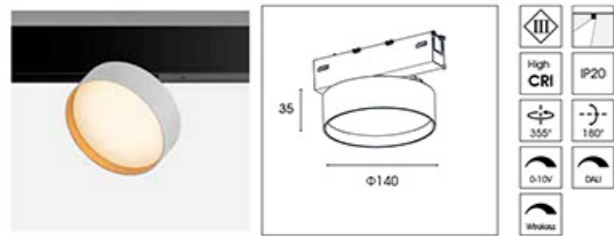
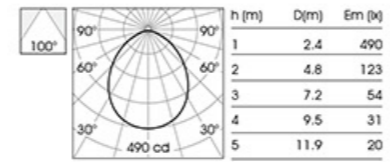

Light Source:
2835 LED

Luminous flux:
1600 lm

CRI:
Ra > 90

CCT:
2700K/3000K/4000K/5000K

Material:
Aluminum

Power:
20W

Output voltage:
DC 24V
DC 48V

Output current:
500mA

OPTIC:
100°

Mains voltage:
220-240V 50/60Hz

Description:
Magnetic suction

Cutout:
/

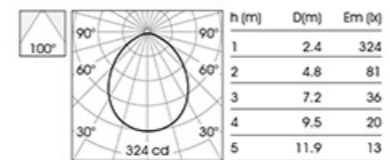

COLORS

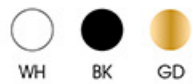

RING'S COLORS



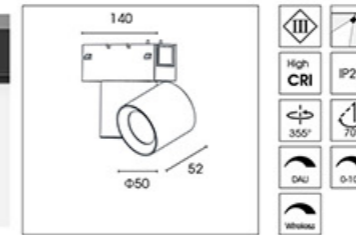
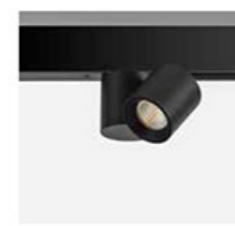

Light Source:
CREE COB

Luminous flux:
500 lm

CRI:
Ra > 90

CCT:
2700K/3000K/4000K/5000K

Material:
Aluminum

Power:
7W

Output voltage:
DC 24V
DC 48V
Output current:
150mA

OPTIC:
15°/24°/36°

Mains voltage:
220-240V 50/60Hz

Description:
Magnetic suction

Cutout:
/

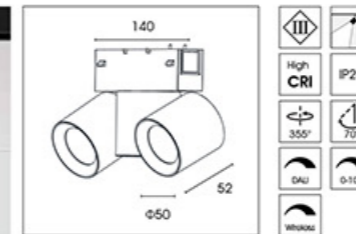
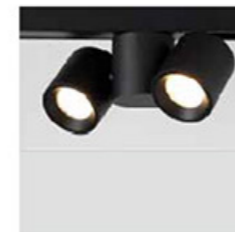
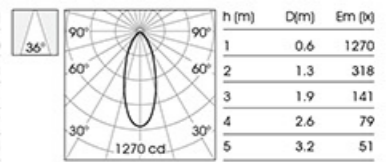
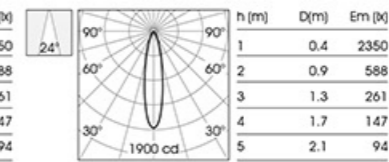
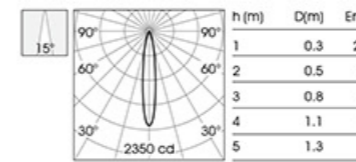

Light Source:
CREE COB

Luminous flux:
500 lm x 2

CRI:
Ra > 90

CCT:
2700K/3000K/4000K/5000K

Material:
Aluminum

Power:
7W x 2

Output voltage:
DC 24V
DC 48V
Output current:
150mA x 2

OPTIC:
15°/24°/36°

Mains voltage:
220-240V 50/60Hz

Description:
Magnetic suction

Cutout:
/

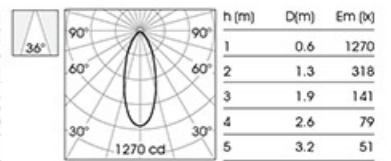
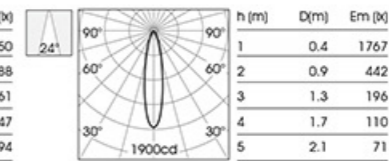
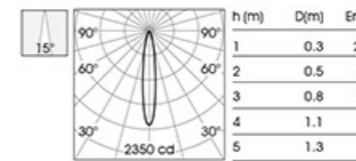

COLORS



ACCESSORIES



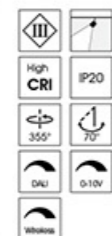
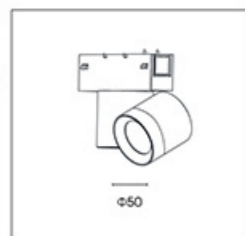

Light Source:
CREE COB

Luminous flux:
500 lm

CRi:
Ra > 90

CCT:
2700K/3000K/4000K/5000K

Material:
Aluminum

Power:
7W

Output voltage:
DC 24V
DC 48V

Output current:
150 mA

OPTIC:
15°/24°/36°

Mains voltage:
220-240V 50/60Hz

Description:
Magnetic suction

Cutout:
/

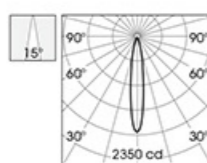

h (m)	D(m)	Em (lx)
1	0.3	2350
2	0.5	546
3	0.8	243
4	1.1	137
5	1.3	87

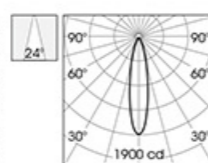

h (m)	D(m)	Em (lx)
1	0.4	1900
2	0.9	475
3	1.3	211
4	1.7	119
5	2.1	76

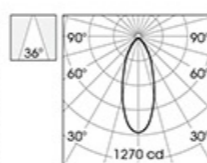

h (m)	D(m)	Em (lx)
1	0.6	1270
2	1.3	318
3	1.9	141
4	2.6	79
5	3.2	51

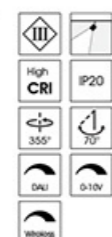
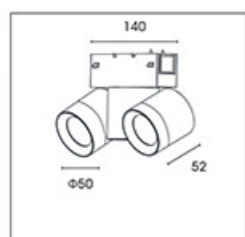
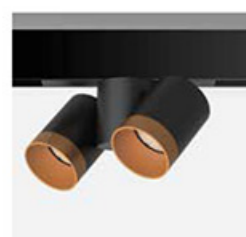

Light Source:
CREE

Luminous flux:
500 lm x 2

CRi:
Ra > 90

CCT:
2700K/3000K/4000K/5000K

Material:
Aluminum

Power:
7W x 2

Output voltage:
DC 24V
DC 48V

Output current:
150mA x 2

OPTIC:
15°/24°/36°

Mains voltage:
220-240V 50/60Hz

Description:
Magnetic suction

Cutout:
/

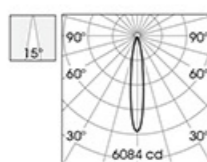

h (m)	D(cm)	Em (lx)
1	0.3	6084
2	0.5	1521
3	0.8	676
4	1.1	380
5	1.3	243

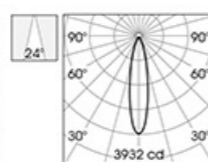

h (m)	D(cm)	Em (lx)
1	0.4	3932
2	0.9	983
3	1.3	437
4	1.7	246
5	2.1	157

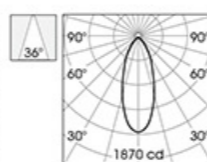

h (m)	D(cm)	Em (lx)
1	0.6	1870
2	1.3	468
3	1.9	208
4	2.6	117
5	3.2	75

COLORS



RING'S COLORS



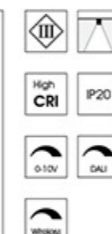
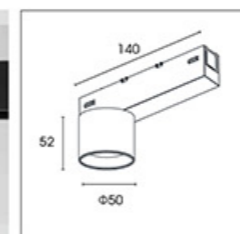

Light Source:
CREE COB

Luminous flux:
500 lm

CRI:
Ra>90

CCT:
2700K/3000K/4000K/5000K

Material:
Aluminum

Power:
7W

Output voltage:
DC 24V
DC 48V
Output current:
150mA

OPTIC:
15°/24°/36°

Mains voltage:
220-240V 50/60Hz

Description:
Magnetic suction

Outout:
/

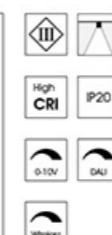
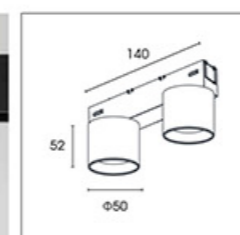
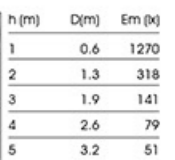
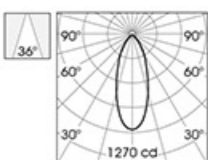
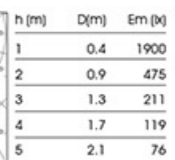
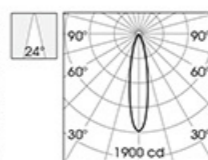
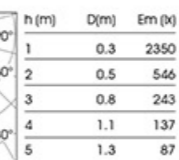
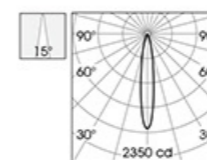

Light Source:
CREE COB

Luminous flux:
500 lm×2

CRI:
Ra>90

CCT:
2700K/3000K/4000K/5000K

Material:
Aluminum

Power:
7W×2

Output voltage:
DC 24V
DC 48V
Output current:
150mA×2

OPTIC:
15°/24°/36°

Mains voltage:
220-240V 50/60Hz

Description:
Magnetic suction

Outout:
/

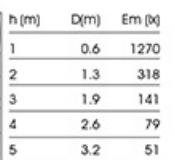
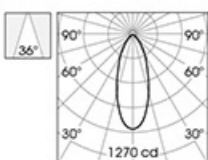
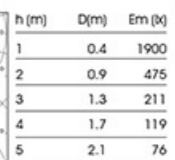
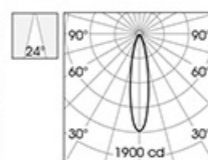
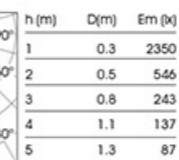
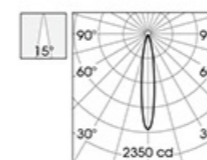

COLORS



ACCESSORIES



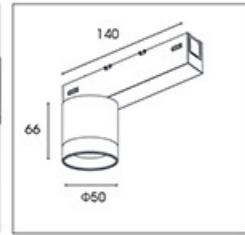

Light Source:
CREE COB

Luminous flux:
450 lm

CRI:
Ra > 90

CCT:
2700K/3000K/4000K/5000K

Material:
Aluminum

Power:
5W

Output voltage:
DC 24V
DC 48V

Output current:
150mA

OPTIC:
15°/24°/36°

Mains voltage:
220-240V 50/60Hz

Description:
Magnetic suction

Cutoff:
/

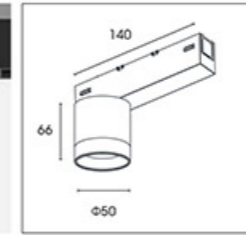
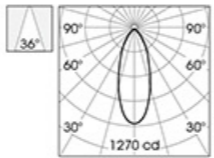
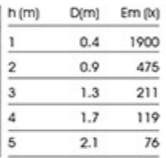
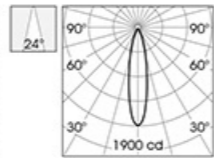
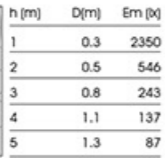
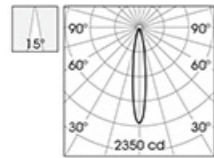

Light Source:
CREE COB

Luminous flux:
500 lm

CRI:
Ra > 90

CCT:
2700K/3000K/4000K/5000K

Material:
Aluminum

Power:
7W

Output voltage:
DC 24V
DC 48V

Output current:
150mA

OPTIC:
15°/24°/36°

Mains voltage:
220-240V 50/60Hz

Description:
Magnetic suction

Cutoff:
/

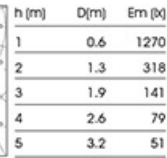
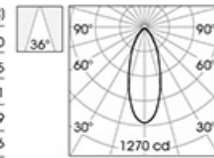
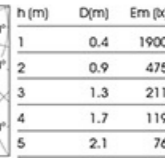
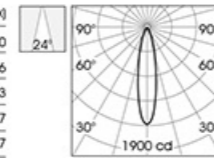
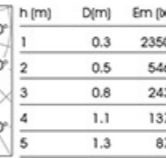
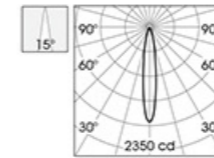

LWA4151R-A

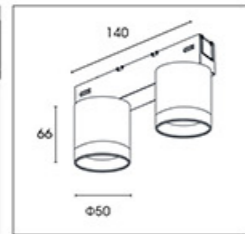

Light Source:
CREE COB

Luminous flux:
450 lm x 2

CRI:
Ra > 90

CCT:
2700K/3000K/4000K/5000K

Material:
Aluminum

Power:
5W x 2

Output voltage:
DC 24V
DC 48V

Output current:
150mA x 2

OPTIC:
15°/24°/36°

Mains voltage:
220-240V 50/60Hz

Description:
Magnetic suction

Cutoff:
/

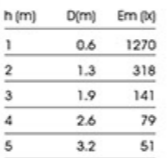
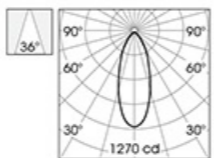
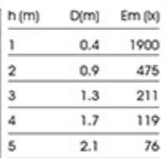
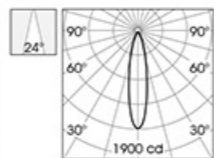
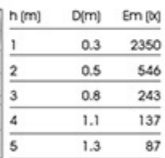
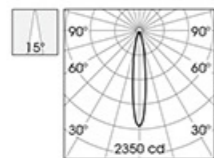

LWA4151R-B

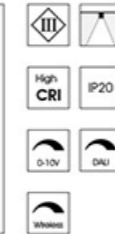
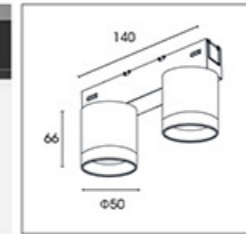

Light Source:
CREE COB

Luminous flux:
500 lm x 2

CRI:
Ra > 90

CCT:
2700K/3000K/4000K/5000K

Material:
Aluminum

Power:
7W x 2

Output voltage:
DC 24V
DC 48V

Output current:
150mA x 2

OPTIC:
15°/24°/36°

Mains voltage:
220-240V 50/60Hz

Description:
Magnetic suction

Cutoff:
/

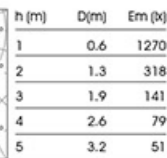
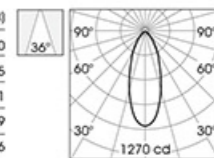
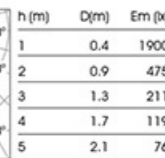
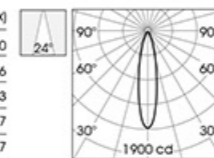
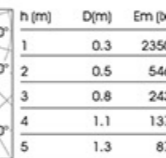
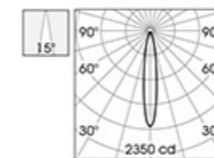

COLORS



COLORS





RING'S COLORS



 +971 588944442

 Hygge_lighting

 Hyggelighting@yahoo.com

 www.hygge-lighting.com

 **HYGGE**
MODERN LIGHTING